



ORTHOPAEDIC
JOINT REPLACEMENT

AESCULAP[®] Bicontact[®]

HIP ENDOPROTHESIS SYSTEM

Bone Preservation. For Years to Come.

AESCULAP® Bicontact® System

30 YEARS: RESULTS, SUCCESS AND EXPERIENCE



CONTENT

OBJECTIVE: Bone preservation	3
APPLICATION: Intraoperative decision-making	4
IMPLANTS: The stem types	6
IMPLANTATION: The Osteoprofilers	7
SURGICAL TECHNIQUE: Primary	8
THE SYSTEM: Revision stems	16
SURGICAL TECHNIQUE: Revision	18
WITH NAVIGATION: OrthoPilot®	26
RESULTS: Literature	28
ORDER INFORMATION: Instruments and implants	30

OBJECTIVE: BONE PRESERVATION



BONE PRESERVATION. FOR YEARS TO COME.

The Bicontact® philosophy is maximum preservation and protection of the existing bone substance.

Based on the simple but crucial fact that the success of the prosthesis fixation depends on both – implant and bone.

To do this, instruments were developed that compress the bone instead of removing it. The Bicontact® system comprises various stem types – for different anatomic morphologies. The modern modular head and cup program completes the Bicontact® system.

The solution for the bone. Satisfied patients.

The Bicontact® Hip Endoprosthesis System:

The bone preserving operation technique for cementless or cemented implantation. For primary and revision surgery.

AESCULAP® Bicontact®

APPLICATION: INTRAOPERATIVE DECISION-MAKING



Bicontact® stems for cementless or cemented implantation:
Coming to the right decision during the operation.

The situation found during the surgery enables or determines the right choice of procedure. The surgeon is free to make a decision, not only before, but also during the operation.

With Bicontact® the possibility exists to decide intraoperatively whether to perform a cementless implantation or to implant with bone cement. The Bicontact® stem can be anchored in the bone either by making use of the Plasmapore® surface or by applying the most recent cementing techniques.

**EXPERIENCE DECIDES. WITH
OR WITHOUT BONE CEMENT.**



Bicontact® with Plasmapore® surface

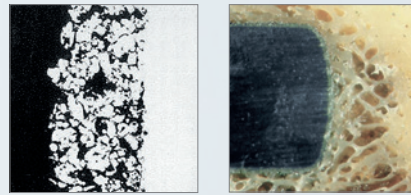

Plasmapore® cross-section and bone contact

The stem range covers different indications and femoral bone conditions. With Bicontact® cementless stems, the Plasmapore® coating supports the integration in the proximal bone structures. The 0.35 mm microporous pure titanium coating with pores of 50 – 200 µm diameter and 35% porosity leads to direct bone apposition.

Bicontact® cemented

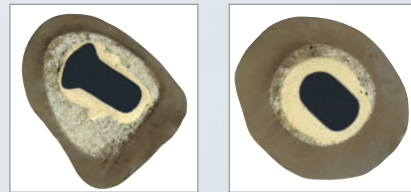

Bicontact® cement embedding proximal and distal

The cemented Bicontact® stems are made of a cobalt-based alloy with a smooth prosthesis surface. The Bicontact® supports the formation of a complete cement mantle. The distal PMMA Centralizer and the bilateral flanges guide the stem into the intermedullary canal.

AESCULAP® Bicontact®

IMPLANTS: THE STEM TYPES



Bicontact® stem types S, H, SD and N

Different bone shapes. Various design solutions.

The Bicontact® implant range comprises stem types for different bone morphologies. Normal, dysplastic and very tight conditions in the marrow cavity.

THE RIGHT Bicontact® STEM FOR EACH CASE.

For normal medullary canal conditions, the Bicontact® stem design offers the standard stem type S or type H (high offset). For smaller bone conditions the Bicontact® SD stems are the suitable choice. For exceptional cases such as extremely severe dysplastic changes with very narrow conditions in the femoral canal, the range of Bicontact® N stems can be chosen.

The characteristic bilateral Bicontact® flanges ensure secure proximal anchoring of all stem variants. The design solutions differ mainly in the upper medial section, which is responsible for anchoring the prosthesis. For all stem types, the distal stem is tapered into a flat, tapered end. During preoperative planning care must be taken that the proximal Bicontact® stem shape determines the implant choice.

IMPLANTATION: THE OSTEOPROFILERS



Biconact® A- AND B-OSTEOPROFILER.

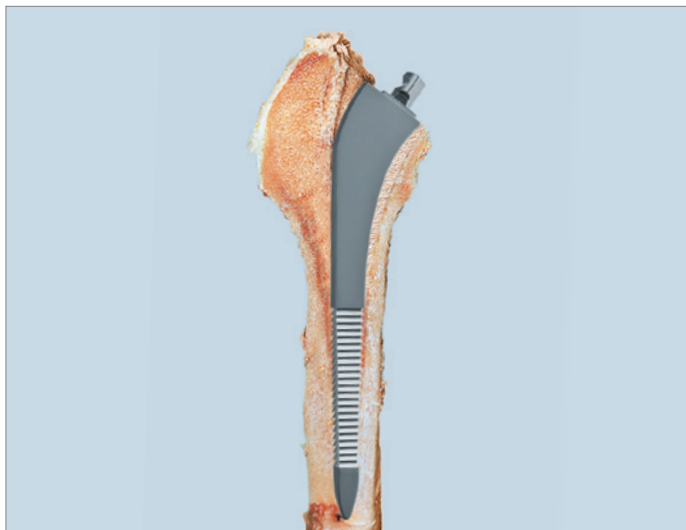

Bone preserving cancellous compression with the A-Osteoprofilier

The A-Osteoprofilier compresses the metaphysal bone, defines the axial stem position and antetorsion and thus obtains a figure for the distal dimension of the medullary canal. With the B-Osteoprofilers the bone will be prepared at the site where the prosthesis will be fixed. For this reason, the proximal part of the B-Osteoprofilier shows the Biconact® design. Due to the proximal anchoring concept, the B-Osteoprofilier determines the dimension of the implant. Therefore, a Biconact® stem does not fix distally but proximally. To achieve this objective with different stem shapes, intraoperatively the appropriate prosthesis type can be chosen: For instance, instead of the S type choose SD type.

The Biconact® can be implanted with the Osteoprofilers in a minimally invasive procedure. As a muscle sparing measure, the trochanteric wing is only prepared in a last step.

AESCULAP® Bicontact®

SURGICAL TECHNIQUE: PRIMARY PROCEDURE

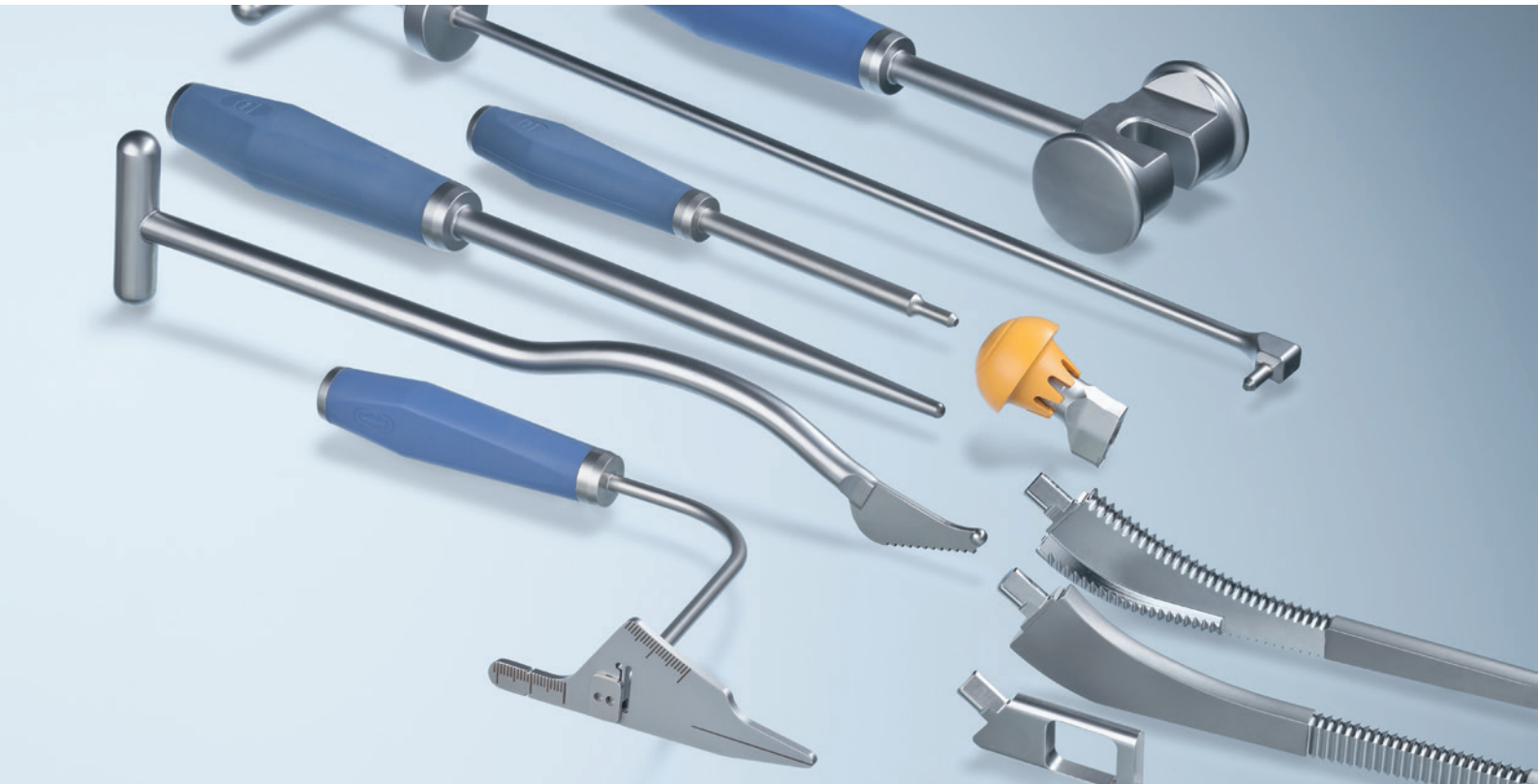

SURGICAL PROCEDURE. THE Bicontact® PRINCIPLE.

Exploiting the adaptability of the bone to the new load situation:
Selecting the appropriate prosthesis stem.

Bicontact® modern platform instruments

The proximal load transfer is today a well established anchoring principle in cementless hip endoprosthetics. This is the principle that we adopted with Bicontact®, straight from the beginning, and which is implemented consistently with the surgical technique.

One and the same procedure for all Bicontact® stem types. Cementless or cemented. With a stem shape selected in preoperative planning or with intraoperative stem selection in situations where the narrow conditions in the femoral stem necessitate the use of a smaller Bicontact® implant.

The modern Bicontact® implantation instrument combines many years of experience, proven methods and the support of correct intraoperative decisions for a reliable treatment of the hip joint.

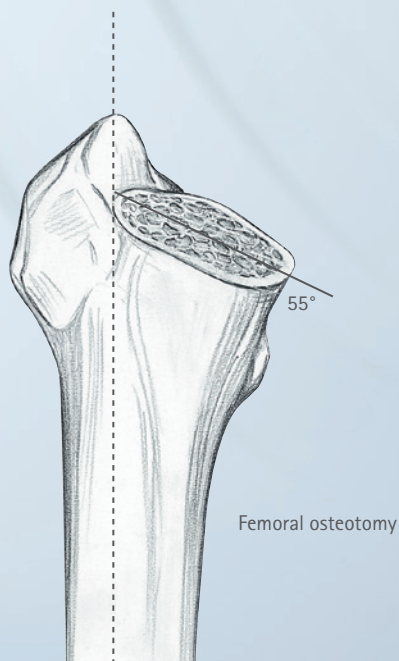

The standard osteotomy plane for Bicontact® is at 55 degrees. A cutting template is provided for determining the osteotomy. The femoral canal is opened with the Bicontact® box osteotome. Opening the lateral femoral cortex is helpful in achieving sufficient lateralization and the correct antetorsion position of the A-Osteoprofilers to be used subsequently. The bone block, which is removed with the box osteotome, is preserved and can be used at a later stage.

NOTE:

The Bicontact® box osteotome is unsuitable for the smallest prosthesis sizes 9 SD, 8 N and 9 N, since the prosthesis stems of these sizes are narrower than the osteotome window. For opening the femoral canal without using the box osteotome the tip of the smallest A-Osteoprofiler (for Bicontact® S, SD or N) is applied on the osteotomy plane as far as possible towards the dorso-lateral side. Then the A-Osteoprofiler is introduced at the correct axial orientation and antetorsion position.

AESCULAP® Bicontact®

A-OSTEOPROFILER



A-Osteoprofiler with proximal compression surfaces



Compression of the proximal bone structures

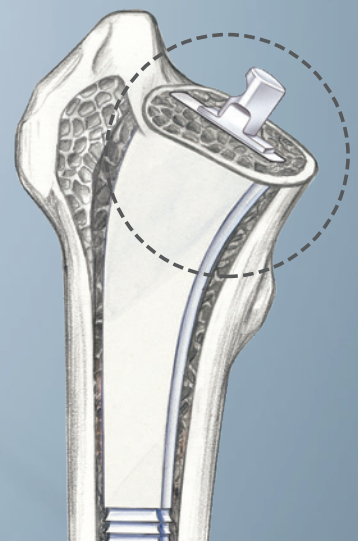

The A-Osteoprofilers are used for compressing the intertrochanteric cancellous bone and thus preserving the bone for anchoring the Bicontact® prosthesis stem.

A-Osteoprofilers of increasing sizes are applied, up to the size of the distal femoral canal. In doing this, tight cancellous structures and sclerotic bone regions must be worked on with particular care in order to prevent a bone fracture.

To achieve sufficient lateralization and axial femoral alignment, the proximal-lateral trochanter region can be prepared with the distal cutting part of an A-Osteoprofiler.

The correct insertion depth of the A-Osteoprofiler is marked in relation to the standard osteotomy plane at 55°.

NOTE:

For normal bone conditions, the size of the A-Osteoprofiler is usually limited by the conditions in the distal (not the proximal) femoral canal. Compared to the B-Osteoprofiler and the Bicontact® stem, the A-Osteoprofilers are cut free medially to compress the cancellous structures in this region.

In cases of narrow conditions at the distal bone and small implant sizes, the A-Osteoprofiler need to be hammered in and out alternately, so that the bone chips can loosen from the profiler teeth, in the distal region. The preparation of a very narrow proximal medullary canal has to be carried out with the smallest A- and B-profilers, alternately, until both can be inserted to the required depth. Use the Bicontact® stem shapes SD or N in such cases. Additional advice is given on page 15 of this document.

B-OSTEOPROFILER

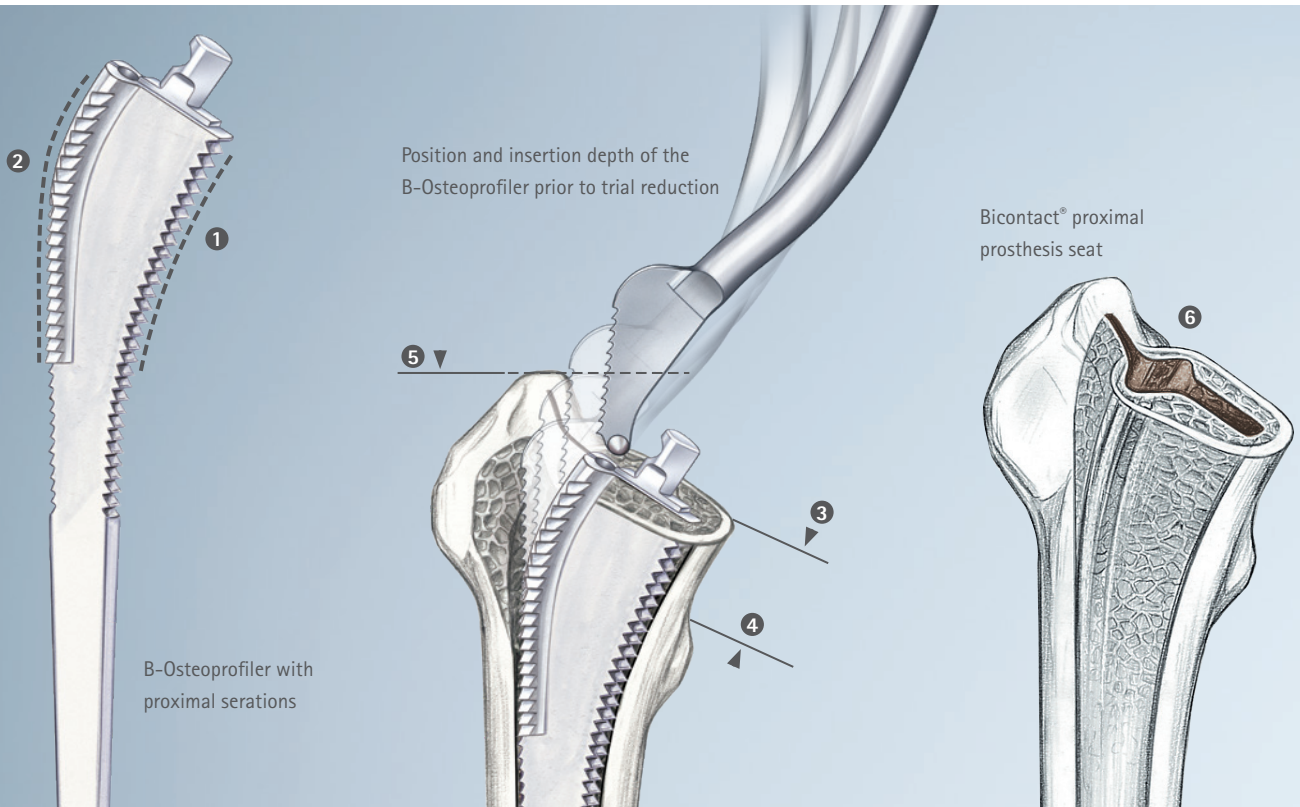

As soon as the selected size of the A-Osteoprofiler has been inserted into the medullary canal, the finishing work is done with the B-Osteoprofilers. Begin with the smallest B-Osteoprofiler or with a B-Osteoprofiler 3 sizes smaller than the A-Osteoprofiler that was used last.

With the B-Osteoprofilers you only prepare the proximal femur in the region of the medial prosthesis support surface, ① the region of the bilateral Bicontact® wings ②. The insertion depth and the selection of the size of the B-Osteoprofiler depend on the position you have planned, preoperatively, for the Bicontact® stem. The insertion depth can be inspected for correctness at the osteotomy plane, ③ the less trochanter ④ and the greater trochanter. ⑤

As a rule, the size of the B-Osteoprofiler corresponds to the size of the A-Osteoprofiler.

The position of the rotation wing in the trochanter major is ⑥ only adjusted as a last step using the wing profiler, which is inserted above the underlying B-Osteoprofilers.

NOTE:

In cases of very narrow proximal bone conditions, the largest B-Osteoprofiler that can be used might have to be one size smaller than the A-Osteoprofiler last inserted into the bone. This choice of Osteoprofiler sizes used for the Bicontact® femur preparation ensures the best possible proximal load transmission for the Bicontact® prosthesis stem. It is a procedure that is characteristic for the Bicontact® surgical concept.

CAUTION:

Never use a larger B-Osteoprofiler as the last A-Osteoprofiler since this would lead to a distal bone fracture.

When applying this technique, the fit and stability of the B-Osteoprofiler and the Bicontact® stem always rest on the proximal bone region, not the distal one.

AESCULAP® Bicontact®

TRIAL REDUCTION



Special Osteoprofiler with complete A and B serrations.
Example: Bicontact® S/H



B-Osteoprofiler with S or H neck adapter and modular trial head

The modular Bicontact® Osteoprofilers allow an intraoperative trial reduction with the B-Osteoprofiler in its final position.

To this end, the modular handle is removed and replaced with trial heads of various neck length. Then, the joint movement, muscle tension and leg length situation are inspected.

For the prosthesis cone 8/10 of the Bicontact® N stems, there is a special set of trial heads available.

Upon request, the Bicontact® Osteoprofilers are also available in a combined A/B serrated design.

NOTE:

It is possible, in principle, to carry out an inspection of the bone preparation (e.g. with an image intensifier) or of the trial reduction, especially in cases of difficult bone conditions, at any stage of the operation.

You can also change intraoperatively from Bicontact® S to SD or from Bicontact® SD to N.

CEMENTLESS IMPLANTATION

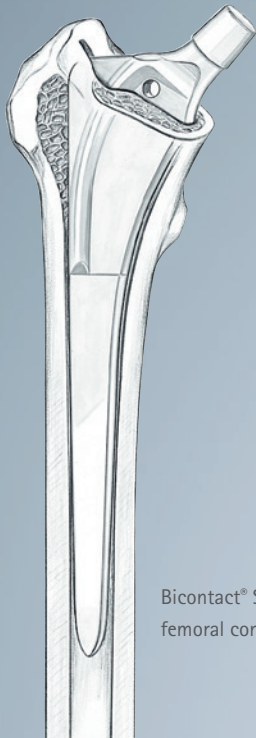

Bicontact® S for normal femoral conditions



Bicontact® SD for narrow and dysplastic femurs

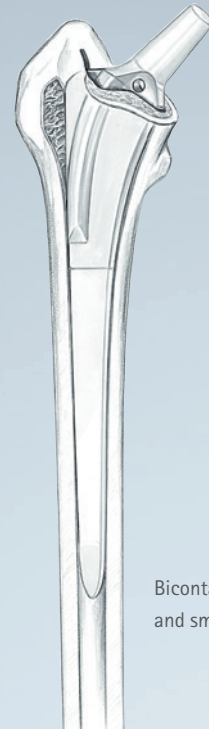

Bicontact® N for very narrow and small femoral canals

Plasmapore®-coated Bicontact® stems are used for cementless implantation. For all Bicontact® stem types (S, H, SD and N), the size of the cementless Bicontact® stem corresponds to the size of B-Osteoprofiler last introduced in the optimum position. The stem is inserted manually and then tapped in, with the punch instrument, down to its final position. The stem has reached the correct insertion depth when the hole of the Bicontact® stem is in line with the osteotomy.

Finally cancellous bone chips in the lateral region around the Bicontact® flanges and the trochanter wing are introduced. This can also be done, if necessary, at the osteotomy plane.

NOTE:

Please note that the osteotomy line, used for intraoperative orientation, may vary. The inspection of the prosthesis insertion depth by means of the greater trochanter or lesser is independent of how the osteotomy is performed.

Special care needs to be taken that the protective cover on the prosthesis cone remains in place during the implantation of the stem, in order to prevent any damage.

Before mounting the prosthesis head, following another trial reduction, the prosthesis cone must be cleaned and dried. The prosthesis head, too, must be installed with the inner cone dry.

AESCULAP® Bicontact®

CEMENTED IMPLANTATION

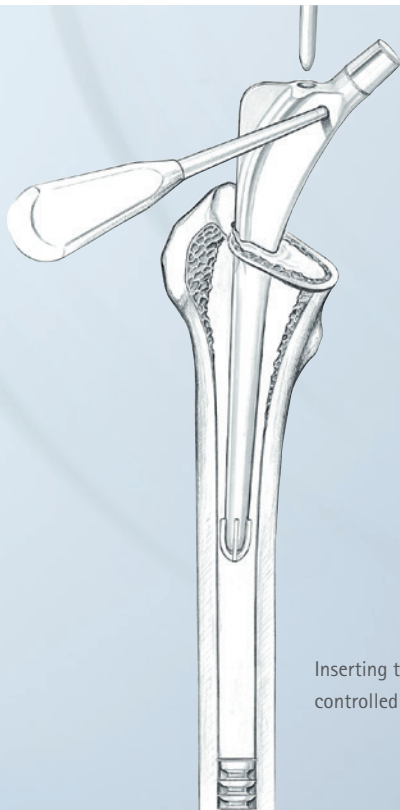

Inserting the Bicontact® stem with controlled rotational position

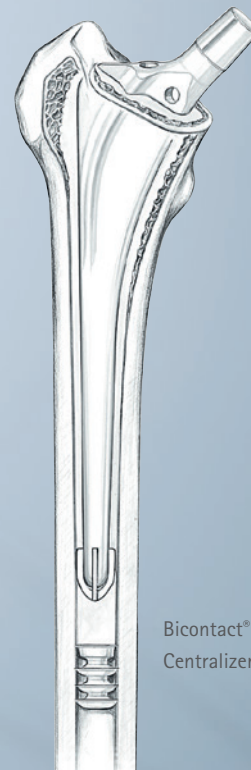

Bicontact® stem position with Centralizer and intermedullary plug

For a cemented stem implantation, an uncoated Bicontact® prosthesis stem is used after an intermedullary plug has been inserted and the cement has been applied.

The size selection of the Bicontact® S prosthesis stems and the distal Centralizer is summarized in the table below, and are also valid for Bicontact® H implants.

Selecting the right stem and Centralizer

B-Osteoprofiler	10 – 11	12 – 13	14 – 15	16 – 17	18 – 19
Bicontact® S/H stem	10*	12	14	16	18
Centralizer	8 mm NK088	10 mm NK090	12 mm NK092	14 mm NK094	16 mm NK096

* Size 10 only available as S-stem.

The stems are inserted manually and kept in a correct rotational position by means of a handle. In the final prosthesis position, the hole is located above the osteotomy plane.

NOTE:

Large intramedullary bone conditions may make it necessary to use a larger Centralizer (+ 2 mm) than the one suggested in the table.

NARROW BONE CONDITIONS

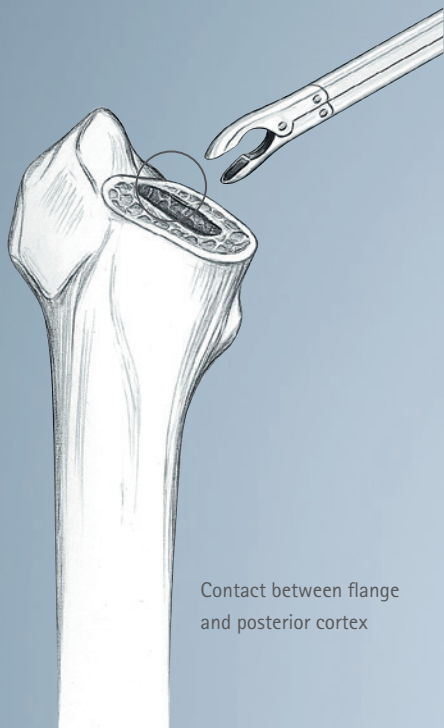

Contact between flange and posterior cortex

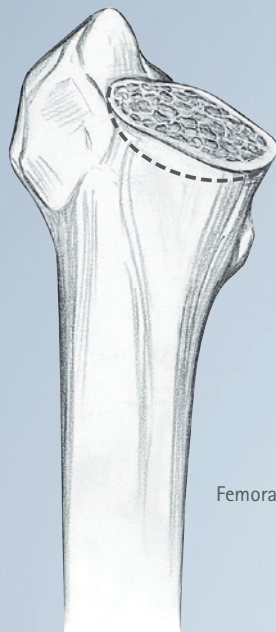

Femoral step osteotomy

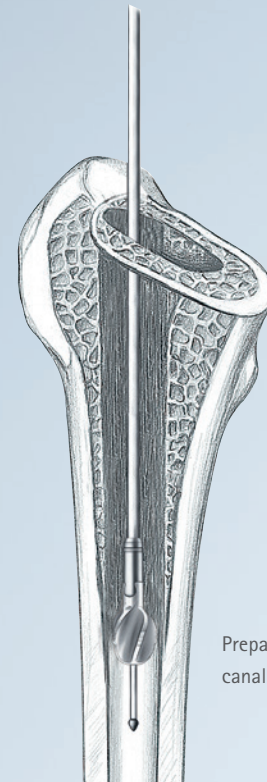

Preparing the femoral canal with flexible reamers

Contact between wing and posterior cortex

The correct fit of the bilateral flanges of the Bicontact® stem is crucial for the stability of the Bicontact® prosthesis stem. If the posterior flange touches the cortex, it may become necessary to widen it with a Luer instrument. In this way, fractures can be prevented.

Femoral step osteotomy

Narrow conditions in the medullary canal may make it necessary to perform a so-called step osteotomy, which will allow inserting the Osteoprofiler and the Bicontact® stem deeper into the cavity. If the osteotomy plane is changed, the intraoperative inspection of the insertion depth has to be performed with the lesser or greater trochanter as a reference level.

NOTE:

Please note that more of the bone is osteotomised in a femoral step osteotomy than in a standard osteotomy, and the force transmission area will be smaller.

Preparing the femoral canal with flexible reamers

In narrower medullary conditions, you can use flexible reamers of a smaller nominal diameter for preparing the distal implant bed. Following this, the preparation is carried out with the A- and B-Osteoprofilers.

nominal size	distal (mm) ap	distal (mm) lateral
Bicontact® S		
10	7.0	6.5
11	8.0	7.0
13	9.0	7.5
Bicontact® SD and N		
9	7.0	6.0
10	8.0	6.5
11	9.0	7.0
12	10.0	7.5

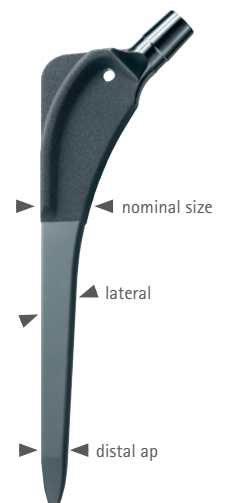

Distal dimensions of the Bicontact® stems for narrow medullary conditions

AESCULAP® Bicontact®

THE SYSTEM: REVISION STEMS

ALL PART OF THE SYSTEM: REVISION WITH BONE RECONSTRUCTION.

The Bicontact® revision stem:

The temporary distal locking mechanism offers additional implant fixation in revision endoprosthetics.

The revision of a hip prosthesis requires a particularly careful procedure. The revision should preserve as much substance as possible and support the reconstruction of the bone. For a revision the implant requires bone substance, for stable fixation.

Therefore, the principle of Bicontact® revision is: bridging the defect zones. With secure locking with screws, if necessary. And, of course, with the proximal Bicontact® design with different stem lengths, straight, curved or SD type for narrow bone conditions.



Bicontact® locking system with aiming device



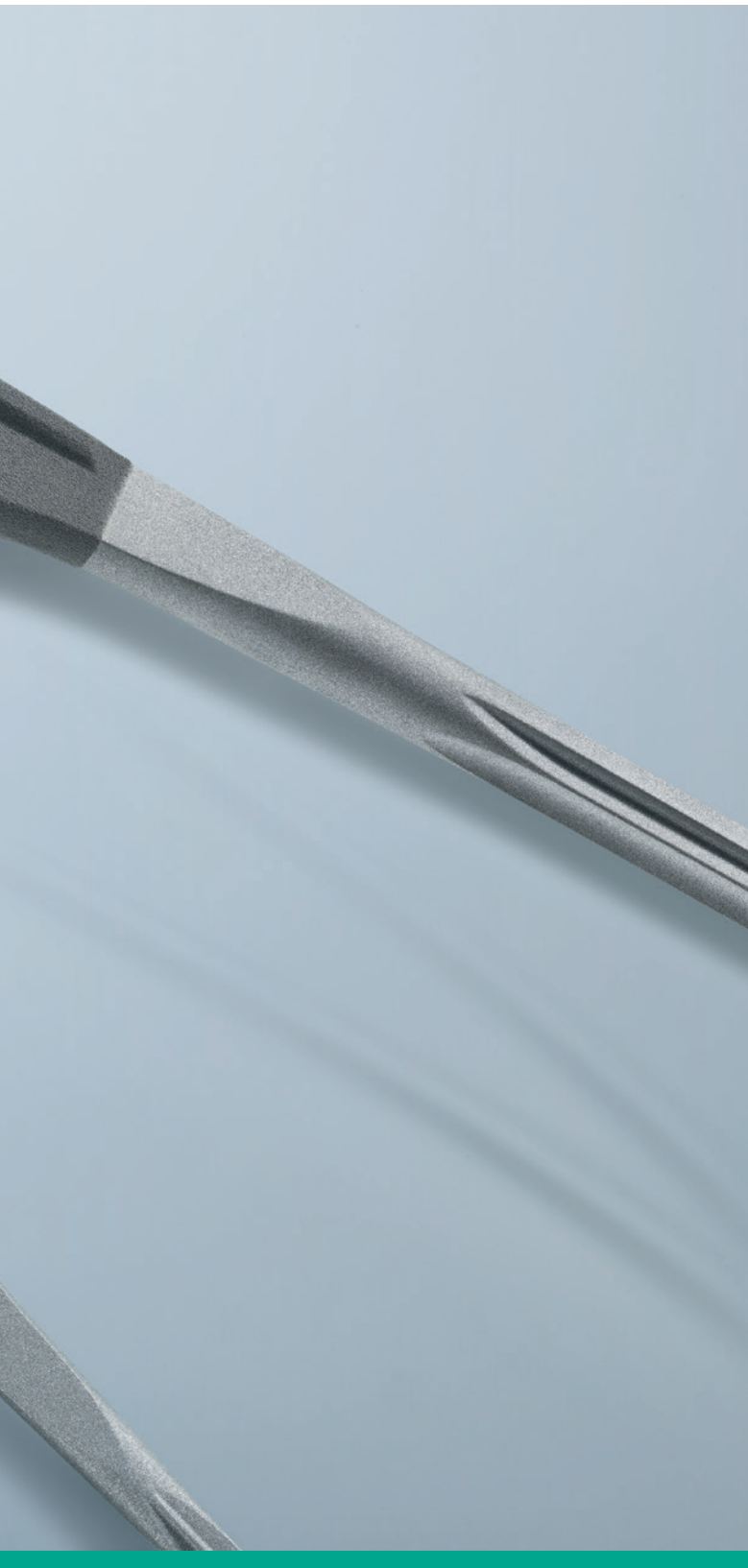

Bicontact® revision stem and Recon Ring

Bridging the bone defect, not filling it up with bone cement or oversized implants. This should be the aim when using the Bicontact® revision stem: Supporting the reconstruction of bone substance.

The proximal Bicontact® stem design and the microporous Plasmapore® coating supports metaphyseal defect filling.

The conical stem design ensures primary stability in the axial dimension. The star-shaped cross section secures the rotational dimension. In cases of large proximal bone loss or a transfemoral operation technique, temporary distal locking with screws is possible. Temporary means, only until the implant is stabilized by the bone substance grown around it.

This stabilization should then work also proximally, as it is the case with all Bicontact® implants.

AESCULAP® Bicontact®

SURGICAL TECHNIQUE: REVISION PROCEDURE

Bettin &
Katthagen (1)

Type 1
Intramedullary defects

Type 2
Intertrochanteric defects

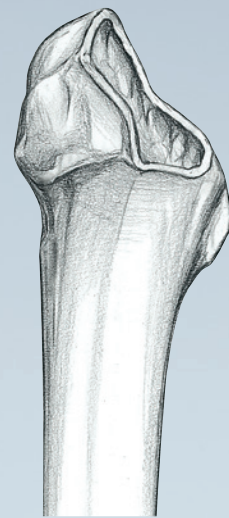
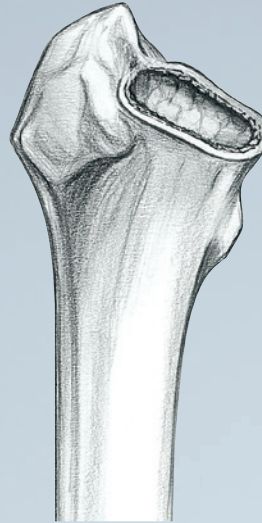

(1) Bettin D, Katthagen BD.
Die DGOT- Klassifikation von Knochendefekten
bei Hüft-Totalendoprothesen – Revisionsoperationen.
Z Orthop. 1997;135:281-4.

(2) Paprosky WG, Lawrence J, Cameron H.
Femoral defect classification: clinical application.
Orthop Rev. 1990;19(Suppl):9-16.

Paprosky (2)

Type I
Slight metaphyseal bone loss

Type II
Moderate metaphyseal bone loss
with intact diaphysis

Bicontact® REVISION. PREOPERATIVE PLANNING.

The basis for a successful procedure: Careful preparation and planning. Foreseeing unexpected situations.

The classification of the defect is very helpful in assessing the preoperative situation to start from. It serves as a guide for choosing the right therapeutic measure (standard implant or revision implant) and helps identifying the optimal operative access (proximal or transfemoral).

In preoperative planning, the following points are taken into account:

- Determining the radiographic scale (e.g. with reference to the head diameter).
- Identifying the stem implant that has come loose. Especially in cases of a separate stem revision, it is necessary to identify the

head diameter without any doubt so that new modular inserts for the cup implant can be made available.

- Identifying the cup implant. Special explantation instruments might be required.
- Planning the provision of the acetabulum with the planned new joint center.
- Planning the required leg length according to the pelvic overview and the situation on the opposite side.
- Assessing the defect situation and the bone quality to be expected in the fixation region for the prosthesis.
- Planning the surgical access (proximal access/transfemoral access).
- If necessary, planning the position of the ventral bone window or, in case of a transfemoral access, the osteotomy line.
- The Bicontact® stem type (standard/revision), prosthesis size and prosthesis length expected to be used.

Type 3
Calcar defects

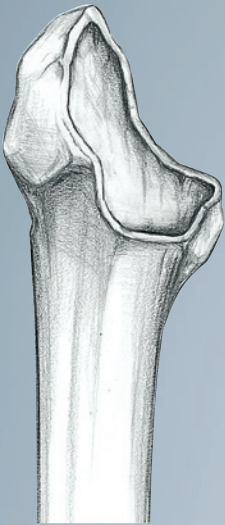

Type 4
Medial femur defects

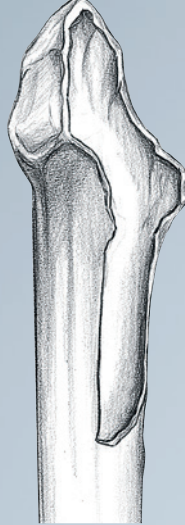

Type 5
Lateral femur defects

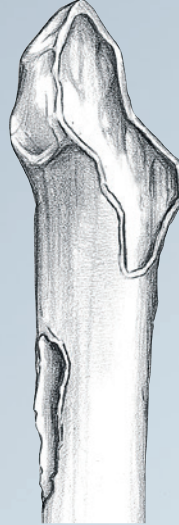

Type 6
Circular, segmental femur defects



Type III a

Severe metaphyseal bone loss
with intact diaphysis above the isthmus

Type III b

Severe segmental bone loss
with supportive bone below the isthmus

- Curvature of the Bicontact® revision stem (curved to the left or to the right), if applicable.
- Anatomic reference points (usually the greater or lesser trochanter) for the intraoperative alignment of the instruments (A- and B-reamers) and the implant. The marks on the reamers correspond to the planned joint center.
- Assessment of the distal bone quality in relation to the distal shape of the Bicontact® revision stem and the possibility of applying additional locking screws.
- Assessing the necessary bone reconstruction measures (allogenic or autogenous bone substance, bone substitutes).

Due to the special situation, preoperative planning can only be a rough guide. The final decision on the procedure to be carried out will be reached intraoperatively. Revision interventions following a failed joint replacement operation require detailed knowledge about indications, surgical access, measures to produce bone reconstruction and limits of treatment.

NOTE:

In situations with only minor bone defects (types 1 – 3), the Bicontact® standard stem, due to its design and length, offers good stability and is, therefore, the preferred implant.

In cases with considerable bone loss and a thinned cortex, or in replacement operations with periprosthetic fractures (types 4 – 6), using the Bicontact® revision stem is indicated.

An intraoperative switch from providing a standard implant to implanting a revision implant is possible. In cases of a loosened prosthesis stem with minor bone losses (types 1 – 4) and the bone tube is intact, proximal access is recommended for removing the implant and the bone cement.

In cases with major bone loss (types 4 – 6) and a partly or completely destroyed bone tube, a transfemoral access is a suitable technique.

AESCULAP® Bicontact®

PROXIMAL TECHNIQUE WITH STANDARD STEM

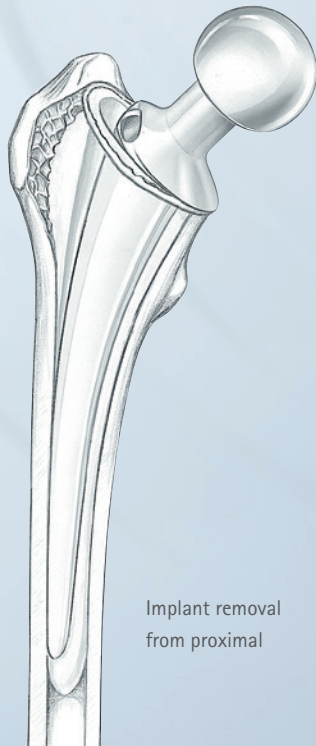

Implant removal
from proximal

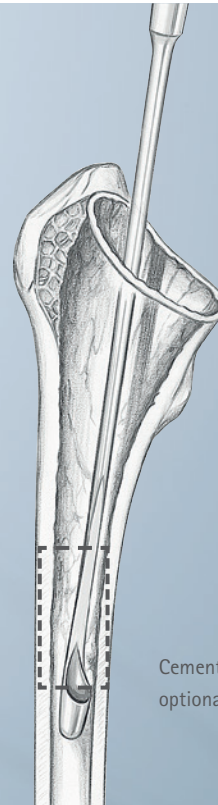

Cement removal,
optional, with bone window

A BONE PRESERVING TECHNIQUE. WHEN THE BONE SITUATION IS GOOD.

High primary stability through existing bone substance.
The aim: Proximal implant anchoring. Bicontact® standard
or revision stem.

The loosened prosthesis stem is removed through proximal access via the existing osteotomy. If the stem is jammed, a special extraction instrument can be applied to the prosthesis cone to facilitate the explantation. Any bone cement in the bone is also removed from the proximal access. Special cement extraction instruments such as drills, chisels, extractors, hooks and sharp spoons, as well as strong forceps, will help to break the cement casing and removing the cement in fragments. The cement must be completely removed. Following the extraction of implants and bone cement, the sequence of bone preparation measures can vary according to the individual bone situation and the choice of implants.

NOTE:

An anterior bone window may be needed for removing the bone cement or the implant. The position and length are selected in preoperative planning.
Care must be taken that the bone window does not get separated from the soft tissue.

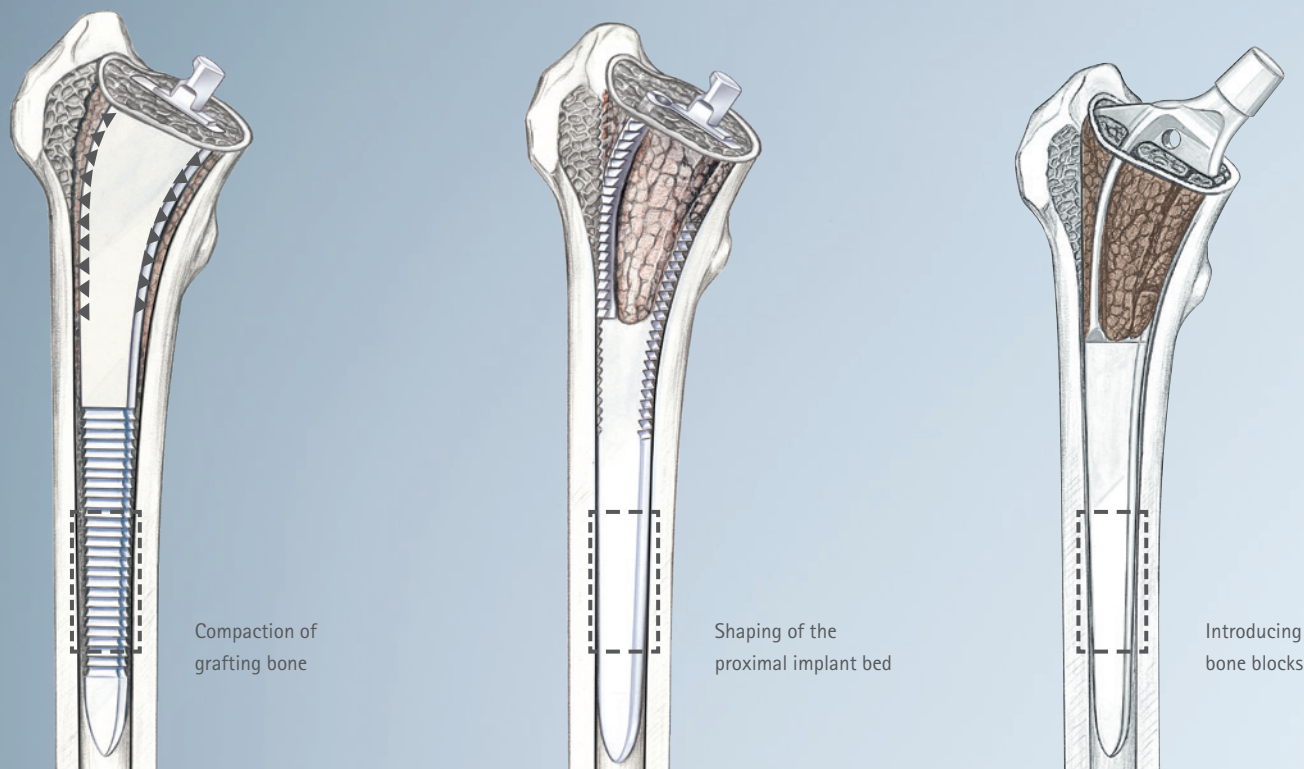

The proximal defects are filled up with allogenic or autogenous bone material and gradually compacted with the A-Osteoprofilers. This procedure can be repeated several times.

When using a Bicontact® standard stem, this compaction procedure is completed with the B-Osteoprofiler. In this, the B-Osteoprofiler used last can also be chosen one size smaller than the implant. However, it is essential that in the preceding compaction process the A- and B-Osteoprofilers corresponding to the implant size could be introduced into the marrow cavity.

Use the last B-Osteoprofiler introduced to check the primary stability achieved. If this stability is found to be insufficient, change to a Bicontact® revision stem (surgical technique described from page 22) or to a cemented stem. If a ventral bone window had been prepared for the removal of the rosthesis, take care that the new prosthesis bridges the bone window.

After the implantation of the Bicontact® stem, cortico-cancellous bone wedges can provide additional stability. Bone blocks in the region of the trochanter wing will increase the rotational stability of the implant.

NOTE:

In cases of minor bone defects and where sufficient amounts of intertrochanteric and proximal bone substance are present, a preparation with the standard Osteoprofilers is recommended. In this procedure, the B-Osteoprofiler usually indicates the maximum size of the proximal bone bed.

In case of an unstable situation with the last B-Osteoprofiler the preparation for a Bicontact® revision stem is carried out. In this, care must be taken that the distal and subproximal bone beds are not overcut. The size of the A- and B-reamers (see next page) must be chosen according to the last B-Osteoprofiler used. In this way, the limited proximal bone cavity must be considered by using the appropriate Bicontact® revision prosthesis.

AESCULAP® Bicontact®

PROXIMAL TECHNIQUE WITH REVISION STEM

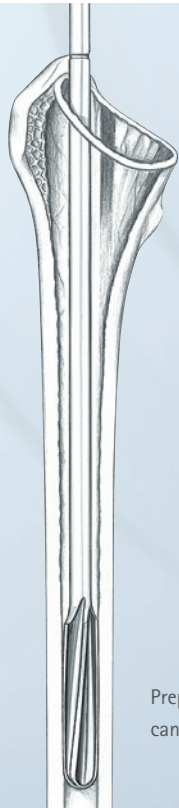

Preparing the distal femoral canal with the A-reamers

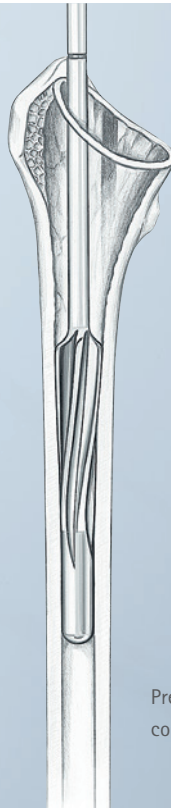

Preparing the subproximal cone with the B-reamer



Implantation of the Bicontact® revision prosthesis

FIRST PRINCIPLE: PRIMARY STABILITY. DISTAL LOCKING.

An important option for ensuring primary stability: The method of temporary locking. In the proximal technique, it is the exception; in the transfemoral technique, it is the rule.

For implanting a Bicontact® revision stem, the distal implant bed is prepared manually, with the A-reamers in ascending size, until a slight cortical contact can be felt. The insertion depth can be checked with reference to the greater trochanter or any other orientation point that was defined preoperatively. The two marking rings on the A-reamers correspond to the joint center of the revision stem. The distal ring applies to the short revision stems of 220–250 mm length, the proximal ring to lengths 290 mm and 300 mm. In the proximal revision technique, the subproximal anchoring is prepared with the B-reamer. The size is selected according to the A-reamer used last. The insertion depth of the

B-reamer is marked by a ring. The final preparation of the proximal implant bed is carried out with the Bicontact® B-Osteoprofilers.

The size is selected according to the reamers and the Bicontact® revision stem to be implanted.

NOTE:

For the distal femoral canal preparation with the A-reamer, limiting or determining the proximal prosthesis size with the B-Osteoprofilers is recommended.

Cases of overcutting or large distal femoral canal may lead to the selection of a prosthesis size that is too large to be inserted into the closed proximal femoral.

When using curved Bicontact® revision stems, the distal canal preparation is carried out with common flexible reamers. As the size description of the Bicontact® revision stems does not indicate the distal stem diameter, the relevant dimensions are listed in the table on the next page.

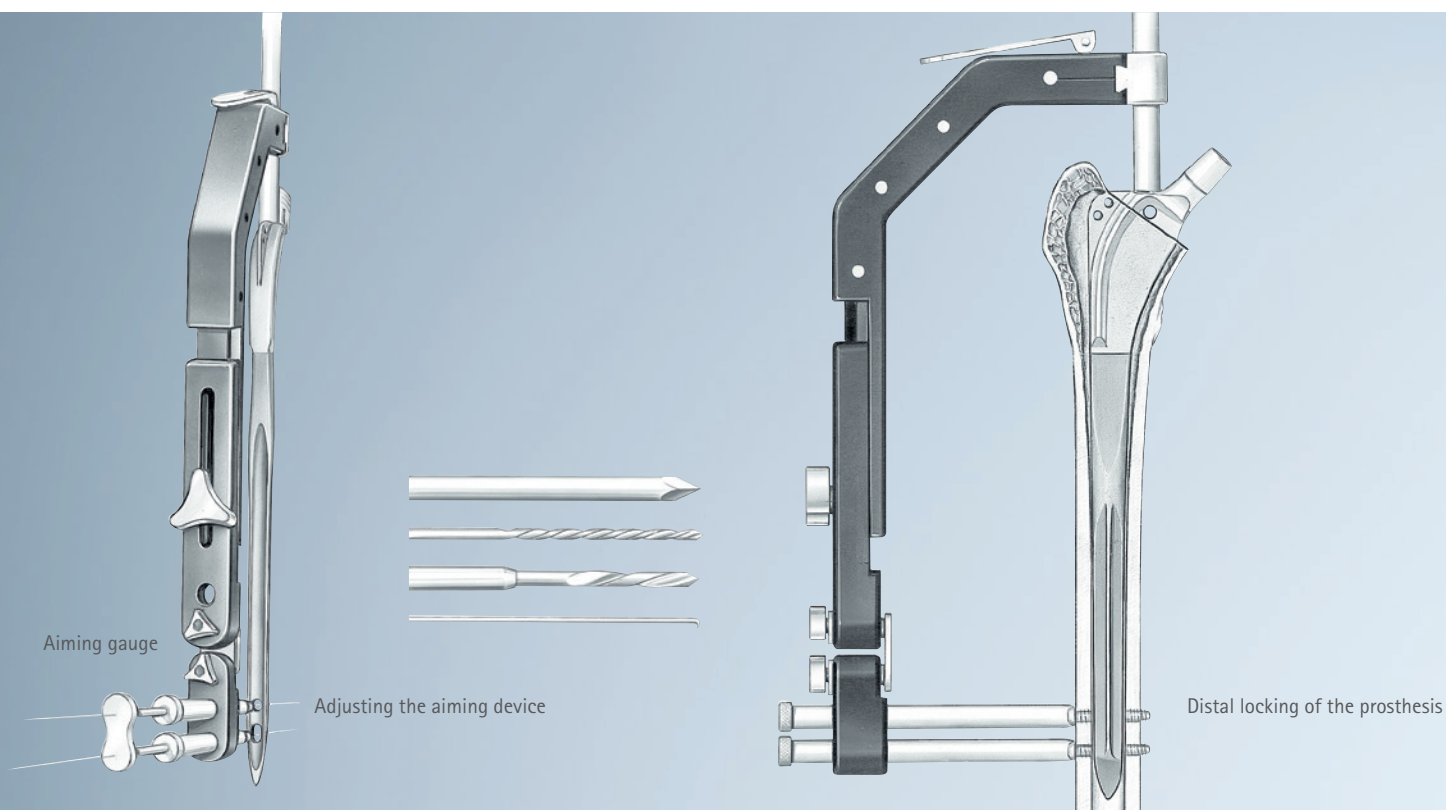

stem size	11	13	15	17	19	19+	19++
distal diameter (mm)	10.0	11.5	13.0	14.5	16.0	17.5	19

The choice of the stem size to be used is based on the instrument size used last and the required stem length. The Bicontact® revision stem is connected to the insertion instrument and introduced into the femur. The proximal revision technique is usually characterized by sufficient primary stability, so that additional distal locking is not required in most cases. If the primary stability is still insufficient, distal locking of the prosthesis is possible. The distal locking can be achieved either in a freehand way, monitored with an image intensifier, or with a special distal aiming device. For locking the Bicontact® revision prosthesis the screw hole is drilled bicortically with a 3.5-mm drill, while the entry cortex is prepared with a 5-mm drill. The screw length is determined with the appropriate screw measuring instrument. Two self-tapping locking screws are introduced with the screwdriver (SW 4.5).

NOTE:

When performing the screw locking with the aiming device, the aiming arm must be adjusted to the individual prosthesis prior to implanting the stem. To this end, the insertion instrument is attached to the prosthesis and the aiming device is attached. Then it is aligned with the prosthesis hole, by means of the aiming gauge. The screws of the aiming arm are securely tightened from proximal to distal. If the aiming gauge gets braced between the prosthesis and the aiming device, all screws must be loosened and the aiming device has to be re-aligned and fixed again in order to ensure proper function. Prior to implanting the prosthesis shaft, the aiming device is slid from the insertion instrument and put down carefully. After the implantation of the prosthesis, it is installed on the insertion instrument again. The tissue protection sleeves serve as working guides for drilling, measuring and introducing the locking screws. Concerning the removal of the locking screws, see note on page 25.

AESCULAP® Bicontact®

TRANSFEMORAL TECHNIQUE



min. 100 mm



Transfemoral opening of the femur and removing the loose prosthesis

A BONE-RECONSTRUCTION TECHNIQUE. WHEN THE BONE SITUATION IS POOR.

Primary stability not provided by proximal bone substance:
Temporary distal anchoring of the Bicontact® revision stem.
Bridging the defect zones and secondary bone reconstruction.

The length of the longitudinal femoral osteotomy is determined in the preoperative planning. As a rule, it corresponds to the length of the loose implant. The Bicontact® stem has to be chosen 10 cm towards distal or per poorer the bone quality and the more weakly the stem is guided in the femoral canal, the longer it should be. Two distal holes (ventral and lateral) are drilled distally for limiting the osteotomy. To protect the femoral bone, a cerclage wire is applied distal to the holes. The lateral osteotomy to the lateral, distal limit hole is performed with an oscillating saw.

The two drill holes are connected. The medial osteotomy is done transmuscularly or transosseously with a narrow osteotome.

In the transosseous osteotomy, the chisel is introduced through the lateral osteotomy opening and led to the opposite cortex, where the bone is perforated from inside. The osteotomised bone shell remains fully connected to the soft tissue environment, and is opened medially. The prosthesis, bone cement, and any granulation tissue that is present are removed and the femoral canal and the osteotomy shell are cleaned.

The distal implant bed is manually prepared, step by step, with the A-reamers until cortical contact can be felt. The marking on the A-reamers corresponds to the intended joint center or, usually, with the tip of the greater trochanter. The proximal marking applies for revision prostheses 290–300 mm long.

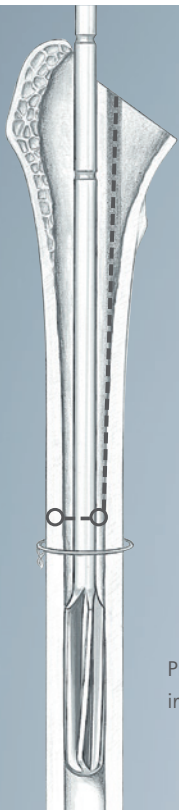

Preparing the distal implant bed

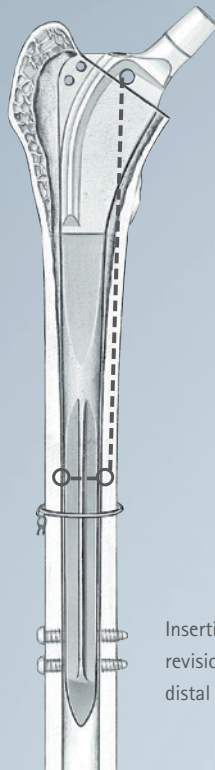

Inserting the Bicontact® revision prosthesis and distal locking screw

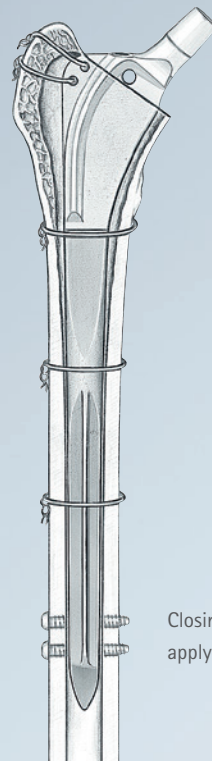

Closing the osteotomy and applying the cerclages

NOTE:

The objective of a treatment with the locked Bicontact® revision stem is to remove the distal locking screws as soon as sufficient bone substance has grown around/on the stem. Load transmission through the locking screws is only possible for a limited period. As soon as osseous implant stabilization is in place, the screws lose their biomechanical function, i.e. primary stabilization, and may affect the force transmission in the middle and proximal bone structures. The surgeon has to decide if or when their explantation becomes necessary, depending on the individual, initial situation and the progress of the treatment.

NOTE:

The osteotomised bone shell is weakened significantly. Therefore, it has to be fixed carefully with bone levers; all manipulations at the leg must be carried out with extreme caution. Because the femur has been opened, the preparation step with the B-reamers is unnecessary in the technique with transfemoral access.

The Bicontact® revision stem to be used is chosen according to the last A-reamer used and the required stem length. Prior to implantation, the proximal medullary canal may be filled up with bone grafts.

The implant is introduced carefully so that a fracture of the femur is avoided. Since preparation with the B-Osteoprofilers is not carried out in the transfemoral technique, it may become necessary to adapt, manually, the proximal bone parts to the Bicontact® design.

The position of the prosthesis and of the bone graft is inspected again prior to distal locking and closing the osteotomy. Larger gaps, which can appear because the osteotomy cover touches the implant, are made narrower by adjusting the bone cover or by further filling with bone graft. With the joint reposition completed, the osteotomy is closed with cerclages. The two anchoring holes in the trochanter wing allow an additional fixation on the implant. As a rule, in the transfemoral technique the Bicontact® revision stem is locked distally.

NOTE:

The primary stability is reduced due to the initial situation and to transfemoral access. This has to be taken into consideration at the aftercare stage. The condition of the bone substance grown around/on the implant (usually during a period of 6 to 24 months) must be assessed in regular postoperative checkups.

AESCULAP® Bicontact®

NAVIGATION: OrthoPilot®



Computer-assisted planning and operation procedures help the surgeon in modern hip replacement. Intelligent instruments support his manual skills. In this way, experience and operating techniques are developed further. Implanting a hip prosthesis requires manual skill and making the right intraoperative decisions. By using a navigation system, the surgeon gains implantation data, which he can compare to his operative procedure, in all surgeries especially the ones where he encounters some difficulties. The navigation system allows recognizing what could be done better not after, but during the operation – better in the sense of different, different in the sense of a better intraoperative decision. For simple operations and more difficult conditions have one thing in common: In both cases, the surgeon strives to provide the best and safest outcome. A successful prosthesis. Fulfilling the expectations of the patients.

AESCULAP® OrthoPilot® *Elite*
TRUST IN YOUR AMBITION.



OrthoPilot® WITH Bicontact® AND Plasmacup®.

Navigation in hip replacement: precision for all surgeries. The OrthoPilot® is therefore the leading navigation system for endoprosthetics.

OrthoPilot® uses the principles of kinematic navigation and intraoperative referencing to optimize the position of cup and stem implants.

OrthoPilot® helps the surgeon with his decision as to what is optimal in each case. Preparing the cup and stem beds in standard, dysplasia and revision cases. Cup position with intraoperative referencing of the pelvic plane. Implanting the stem with controlled antetorsion position and navigation support for finding the relative or absolute head center and positioning of the acetabular implant.

All leg length and offset changes, as well as the axial stem position, are displayed on the real-time monitor. As a result, OrthoPilot® provides a simulation of the range of motion and the joint stability. With OrthoPilot® hip navigation, this result is prepared during the operation and thus provides real time input for intraoperative decision-making.

AESCULAP® Bicontact®

RESULTS: LITERATURE

Weller S, Rupf G, Ungethüm M, Stallforth H.

Das Bicontact Hüftendoprothesensystem – ein zementfrei oder zementiert implantierbares, femurschaftadaptiertes Hüftendoprothesensystem. *Medizinisch-Orthopädische Technik*. 1988;6:222-7.

Volkman R.

Das Bicontact Endoprothesensystem – mittelfristige Ergebnisse nach 5jähriger Anwendung. *Aktuelle Traumatol*. 1993 Jul;23 Suppl 1:75-81.

Fink U.

Plasmapore: a plasma-sprayed microporous titanium coating to improve the long term stability. In: Mainard D, editor. *Acutalités en Biomatériaux Vol. III*. Paris: Romillat Edit. 1996. p. 97-104.

Eingartner C, Volkman R, Pütz M, Weller S.

Niedrige Lockerungsrate einer zementierten Titan-Gradschaftprothese im längerfristigen Verlauf. *Swiss Surg*. 1997;3:49-54.

Eingartner C, Volkman R, Pütz M, Weller S.

Uncemented revision stem for biological osteosynthesis in periprosthetic femoral fractures. *Int Orthop*. 1997;21(1):25-9.

Asmuth T, Bachmann J, Eingartner C, Feldmann C, aus der Fünten K, Holz F, et al.

Results with the cementless Bicontact stem – multicenter study of 553 cases. In: Weller S, Volkman R, editors. *The Bicontact hip system*. Stuttgart: Thieme Verlag. 1998. p. 63-74.

Volkman R, Eingartner C, Winter E, Weise K, Weller S.

Midterm results in 500 titanium alloy femoral stem prostheses – cemented and cementless technique. *Eur J Orthop Surg Traumatol*. 1998;8:133-9.

Weller S, Braun A, Gekeler J, Volkman R, Weise K.

Das Bicontact Hüftendoprothesen System. Stuttgart: Thieme Verlag. 1998.

Weller S, Braun A, Gellrich JC, Gross U.

Importance of prosthesis design and surface structure for primary and secondary stability of uncemented hip joint prostheses. In: Learmonth ID, editor. *Interfaces in total hip arthroplasty*. London: Springer Verlag. 1999. p. 81-101.

Eingartner C, Volkman R, Winter E, Maurer F, Sauer G, Weller S, et al.

Results of an uncemented straight femoral shaft prosthesis after 9 years of follow-up. *J Arthroplasty*. 2000 Jun;15(4):440-7.

Eingartner C, Maurer F, Sauer G, Winter E, Weise K, Weller S.

Langzeitergebnisse mit dem Bicontact-Schaft. *Aktuelle Traumatol*. 2001 Aug;31:149-55.

Eingartner C, Volkman R, Winter E, Weise K, Weller S.

A long straight stem with distal interlocking for uncemented stem revision in THR. In: Szabo Z, editor. *Surgical Technology International IX*. San Francisco: Universal Medical Press Inc. 2001. p. 273-9.

Flamme CH, Wirth CJ, Stukenborg-Colsman C.

Charakteristik der Lernkurve bei der Hüfttotalendoprothese am Beispiel der Bicontact-Prothese. *Z Orthop Ihre Grenzgeb*. 2001 May-Jun;139(3):189-93.

Badhe NP, Quinell RC, Howard PW.

The uncemented Bicontact total hip arthroplasty. *J Arthroplasty*. 2002 Oct;17(7):896-901.

Braun A, Papp J, Reiter A.

The periprosthetic bone remodelling process – signs of vital bone reaction. *Int Orthop*. 2003;27 Suppl 1:7-10.

Eingartner C, Heigele T, Dieter J, Winter E, Weise K.

Long-term results with the Bicontact system – aspects to investigate and to learn from. *Int Orthop*. 2003;27 Suppl 1:11-5.

Reiter A, Gellrich JC, Bachmann J, Braun A.

Verlauf der periprosthetischen Mineralisationsdichte nach Implantation des zementfreien Bicontact-Schaftes; Einfluss verschiedener Parameter – ein prospektives Follow-up über 4 Jahre. *Z Orthop Ihre Grenzgeb*. 2003 May-Jun;141(3):283-8.

Volkman R, Bretschneider C, Eingartner C, Weller S.

Revision arthroplasty – femoral aspect: the concept to solve high grade defects. *Int Orthop*. 2003;27 Suppl 1:24-8.

Kim YM, Kim HJ, Song WS, Yoo JJ.

Experiences with the Bicontact revision stems with distal interlocking. *J Arthroplasty*. 2004 Jan;19(1):27-34.

Eingartner C, Ilchmann T, Dieter J, Weise K.

Subsidence pattern of a cementless straight titanium alloy femoral stem – a radiographic study with EBRA-FCA. *Hip Int*. 2005;15(2):85-91.

Yoo JJ, Kim YM, Yoon KS, Koo KH, Song WS, Kim HJ.

Alumina-on-alumina total hip arthroplasty. A five-year minimum follow-up study. *J Bone Joint Surg Am*. 2005 Mar; 87(3):530-5.

- Eingartner C, Volkmann R, Ochs U, Egetemeyr D, Weise K.**
Intramedullary stabilization of periprosthetic fractures of the femur taking special account of bone defects. *Oper Orthop Traumatol.* 2006 Oct;18(4):341-63.
- Braun A, Acker M.**
Bicontact Plasmacup THA in patients with staged bilateral hip replacement. *Z Orthop Unfall.* 2007 Sep-Oct;145 Suppl 1:9-12.
- Eingartner C, Ochs U, Egetemeyr D, Volkmann R.**
Treatment of periprosthetic femoral fractures with the Bicontact revision stem. *Z Orthop Unfall.* 2007 Sep-Oct;145 Suppl 1:29-33.
- Eingartner C, Piel K, Weise K.**
Results of a cemented straight titanium alloy femoral stem after mean follow-up of 13 years. *Eur J Orthop Surg Traumatol.* 2007;17:587-93.
- Kiefer H, Othman A.**
The Orthopilot navigation system for primary Bicontact total hip replacement. *Z Orthop Unfall.* 2007 Sep-Oct;145 Suppl 1:49-52.
- Kohler S, Nahmmacher V.**
12-year results with the cementless Bicontact SD stem in dysplastic and narrow femoral bone conditions. *Z Orthop Unfall.* 2007 Sep-Oct;145 Suppl 1:13-9.
- Ochs BG, Volkmann R, Eingartner C, Ludolph I, Weller S, Weise K, et al.**
Treatment of large femoral bone defects – 15-year experiences with the cementless Bicontact revision stem with distal interlocking. *Z Orthop Unfall.* 2007 Sep-Oct;145 Suppl 1:34-9.
- Ochs U, Eingartner C, Volkmann R, Ochs BG, Huber C, Weller S, et al.**
Prospective long-term follow-up of the cementless Bicontact hip stem with plasmapore coating. *Z Orthop Unfall.* 2007 Sep-Oct;145 Suppl 1:3-8.
- Takata ET, Basile R, Albertoni WM.**
Experiences with Bicontact ceramic-ceramic total hip arthroplasty. *Z Orthop Unfall.* 2007 Sep-Oct;145 Suppl 1:25-8.
- Thorey F, Lerch M, Kiel H, von Lewinski G, Stukenborg-Colsman C, Windhagen H.**
The uncemented primary Bicontact stem in revision total hip arthroplasty in young patients. *Z Orthop Unfall.* 2007 Sep-Oct; 145 Suppl 1:40-3.
- Volkmann R, Bretschneider K, Erlekamp E, Weller S.**
Revision surgery in high grade acetabular defects with thermodisinfected allografts. *Z Orthop Unfall.* 2007 Sep-Oct;145 Suppl 1: 44-8.
- Thorey F, Lerch M, Kiel H, von Lewinski G, Stukenborg-Colsman C, Windhagen H.**
Revision total hip arthroplasty with an uncemented primary stem in 79 patients. *Arch Orthop Trauma Surg.* 2008 Jul;128(7):673-8.
- Lee YK, Ha YC, Yoo JJ, Koo KH, Yoon KS, Kim HJ.**
Alumina-on-alumina total hip arthroplasty: a concise followup, at a minimum of ten years, of a previous report. *J Bone Joint Surg Am.* 2010 Jul 21;92(8):1715-9.
- Ki SC, Kim BH, Ryu JH, Yoon DH, Chung YY.**
Squeaking sound in total hip arthroplasty using ceramic-on-ceramic bearing surfaces. *J Orthop Sci.* 2011 Jan;16(1):21-5.
- Swamy G, Pace A, Quah C, Howard P.**
The Bicontact cementless primary total hip arthroplasty: long-term results. *Int Orthop.* 2012 May;36(5):915-20.
- Lerch M, Kurtz A, Windhagen H, Bouguecha A, Behrens BA, Wefstaedt P, Stukenborg-Colsman CM.**
The cementless Bicontact stem in a prospective dual-energy X-ray absorptiometry study. *Int Orthop.* 2012 Nov;36(11):2211-7.
- Agarwala S, Jhunjunwala, Pachore JA, Joglekar SB, Eachempati KK.**
Results of uncemented distal locked prosthesis in revision hip arthroplasty with proximal femoral bone loss: A retrospective study. *Indian J Orthop.* 2013 Jan-Feb;47(1):83-6.
- Drobniewski M, Borowski A, Synder M, Sibiński M.**
Cementless Total Hip Arthroplasty with BiCONTACT Stem – Good Results at Long Term of Follow-up. *Ortop Traumatol Rehabil.* 2014;1(6);Vol16:91-4.
- Ateschrang A, Weise K, Weller S, Stöckle U, de Zwart P, Ochs BG.**
Long-term results using the straight tapered femoral cementless hip stem in total hip arthroplasty: a minimum of twenty-year follow-up. *J Arthroplasty.* 2014 Aug;29(8):1559-65.
- Tsukada S, Wakui M.**
A Case Series of Total Hip Arthroplasty Using Cementless Hip Stem Customized for Patients of a Specific Race: 10- to 15-Year Results. *J Arthroplasty.* 2016 Jan;31(1):190-3.

AESCULAP® Bicontact®

S/H INSTRUMENTS

Bicontact® S/H Instruments NT100

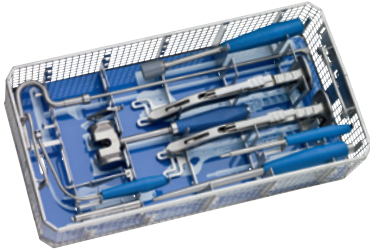

Trial Heads and Neck Adapters

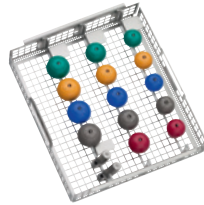

Bicontact® S/H Osteoprofiler NT102

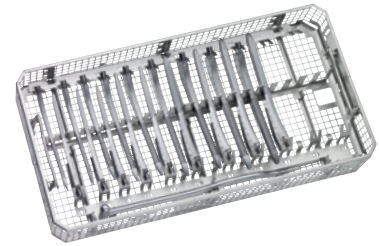

Bicontact® S/H instruments

Basket tray with support and insert for trial heads 485 x 253 x 106 mm	NT101R
Basket lid	JH217R*
Graphic template	TE997
Femoral head saw guide	ND058R
Box osteotome modular	NT053R
Impaction instrument	ND830R
Insertion handle	ND824R
Extraction instrument	ND855R
Impactor for heads	ND060
Slotted hammer	ND476R
Cross bar for handles	ND017R

Storage tray insert

Insert for trial heads and trial neck adapter, enclosed at NT101R

Bicontact® TRIAL HEADS CONE 12/14

Size	28 mm	32 mm	36 mm
S	NT356	NT366	NT376*
M	NT357	NT367	NT377*
L	NT358	NT368	NT378*
XL	NT359	NT369	NT379*
XXL	NT360	NT370	NT380*

Trial neck adapter for Bicontact® S NT055R

Trial neck adapter for Bicontact® H NT056R

Bicontact® A- and B-Osteoprofiler

Basket tray with support 485 x 253 x 76 mm NT103R

Bicontact® OSTEOPROFILER

Size	A	B
10	NT060R	NT080R
11	NT061R	NT081R
12	NT062R	NT082R
13	NT063R	NT083R
14	NT064R	NT084R
15	NT065R	NT085R
16	NT066R	NT086R
17	NT067R	NT087R
18	NT068R	NT088R
19	NT069R*	NT089R*
21	NT071R*	NT091R*

Bicontact® wing profiler NT054R

Osteoprofiler handles

Lateral approach, straight	NT001R*
Lateral approach, left	NT004R*
Lateral approach, right	NT005R*
Posterior approach, straight	NT002R*
Anterior approach, straight	NT003R*
Anterior approach, left	NT006R*
Anterior approach, right	NT007R*

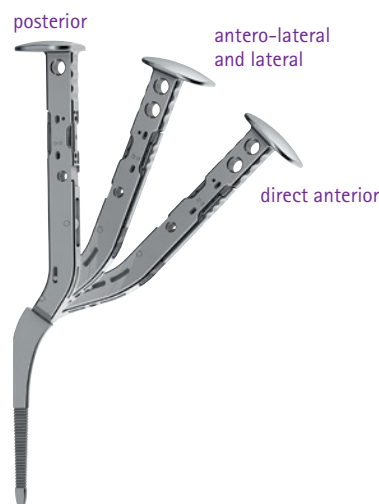

2 Osteoprofiler handles can be placed in the set NT100.

Recommended container for NT100 and NT102: AESCULAP® Basic Container 592 x 285 x 265 mm.

Instruments signed with a * please order separately.

S/H AND SD COMPACT INSTRUMENTS

Bicontact® S/H Compact Instruments NT104

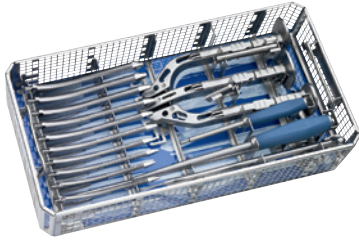

Trial Heads and Neck Adapters

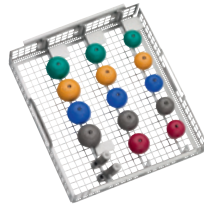

Bicontact® SD Compact Instruments NT106

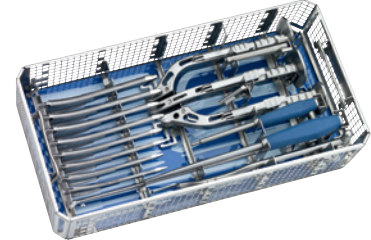

Bicontact® S/H compact instruments

Basket tray with support trial and insert for trial heads	NT105R
Basket lid	JH217R*
Graphic template	TE998
Box osteotome modular	NT053R
Impaction instrument	ND830R
Insertion handle	ND824R
Extraction instrument	ND855R
Cross bar for handles	ND017R
Wing profiler	NT054R
S/H Osteoprofiler 10 mm	NT020R
S/H Osteoprofiler 11 mm	NT021R
S/H Osteoprofiler 12 mm	NT022R
S/H Osteoprofiler 13 mm	NT023R
S/H Osteoprofiler 14 mm	NT024R
S/H Osteoprofiler 15 mm	NT025R
S/H Osteoprofiler 16 mm	NT026R
S/H Osteoprofiler 17 mm	NT027R
S/H Osteoprofiler 18 mm	NT028R
S/H Osteoprofiler 19 mm	NT029R*
S/H Osteoprofiler 21 mm	NT031R*

Storage tray insert

Insert for trial heads and trial neck adapter, enclosed at NT105R

Bicontact® TRIAL HEADS CONE 12/14

Size	28 mm	32 mm	36 mm
S	NT356	NT366	NT376*
M	NT357	NT367	NT377*
L	NT358	NT368	NT378*
XL	NT359	NT369	NT379*
XXL**	NT360	NT370	NT380*
Trial neck adapter for Bicontact® S			NT055R
Trial neck adapter for Bicontact® H (only in set NT104)			NT056R

** Only available for Bicontact® S/H Compact Set NT104, not for Bicontact® SD Set NT106.

NOTE

Osteoprofiler Handles see left page 30.

Bicontact® SD compact instruments

Basket tray with support and insert for trial heads 485 x 253 x 106 mm	NT105R
Basket lid	JH217R*
Graphic template	TE999
Box osteotome modular	NT053R
Impaction instrument	ND830R
Insertion handle	ND824R
Extraction instrument	ND855R
Cross bar for handles	ND017R
Wing profiler	NT054R
SD Osteoprofiler 9 mm	NT289R
SD Osteoprofiler 10 mm	NT290R
SD Osteoprofiler 11 mm	NT291R
SD Osteoprofiler 12 mm	NT292R
SD Osteoprofiler 13 mm	NT293R
SD Osteoprofiler 14 mm	NT294R
SD Osteoprofiler 15 mm	NT295R
SD Osteoprofiler 16 mm	NT296R

3 Osteoprofiler handles can be placed in the set NT104 and NT106.

Recommended container for NT100 and NT102: AESCULAP® Basic Container 592 x 285 x 153 mm.

Instruments signed with a * please order separately.

AESCULAP® Bicontact®

N INSTRUMENTS

Bicontact® N Instruments NG110

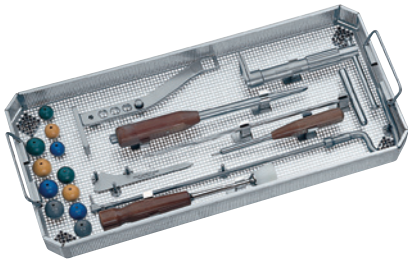

Bicontact® N Osteoprofiler NG112



Bicontact® N instruments

Basket tray with support 540 x 254 x 56 mm	NG111R
Femoral head saw guide	ND004R
Box osteotome	FS914R
Impaction instrument	ND830R
Insertion handle	ND363R
Impactor for heads	ND060
Extraction instrument	ND387R
Start reamer	ND390R
Prosthesis head remover	ND382R

Bicontact® N Osteoprofiler

Basket tray with support 540 x 254 x 56 mm	NG113R
2 handles (lateral approach)	NG115R

Bicontact® OSTEOPROFILER

Size	A	B
9	NG119R	NG139R
10	NG120R	NG140R
11	NG121R	NG141R
12	NG122R	NG142R
13	NG123R	NG143R
14	NG124R	NG144R
15	NG125R	NG145R
16	NG126R	NG146R

Trial heads for cone 8/10

mm	22.2	28	32
short	NG281	NG301	NG316
middle	NG282	NG302	NG317
long	NG283	NG303	NG318
x-long	-	NG304	NG319
xx-long	-	NG305	NG320

Trial heads Osteoprofiler

mm	22.2	28	32
short	NG311*	NG331*	NG231*
middle	NG312*	NG332*	NG232*
long	NG313*	NG333*	NG233*
x-long	-	NG334*	NG234*
xx-long	-	-	-

Recommended container for NG110 and NG112: AESCULAP® Basic Container 592 x 285 x 153 mm.

Instruments signed with a * please order separately.

REVISION INSTRUMENTS

Bicontact® Revision Instruments NF420

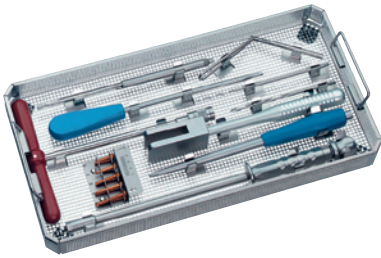

Bicontact® Revision Reamers NF422



Bicontact® Revision Aiming Device NF510

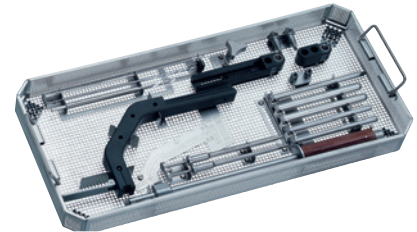

Bicontact® revision instruments

Basket tray with support 485 x 254 x 56 mm	NF419R
Insertion instrument	NF332R
Hexagonal key for NF332R	NF334R
Slotted hammer for NF332R	NF275R
Impaction instrument	NF333R
T-handle, HARRIS	ND145R
Twist drill, 3.5 mm, AO-chuck	KH287R
Twist drill, 5.0 mm, AO-chuck	KH288R
Screw driver, hex 4.5 mm	KH322R
Screw measuring instrument	KH295R
Drill guide	LS110R

Bicontact® revision reamers

Basket tray 56 mm with supports	NF423R
------------------------------------	--------

Bicontact® REVISION REAMERS

Size	A	B
11	NF461R*	NF431R*
13	NF463R	NF433R
15	NF465R	NF435R
17	NF467R	NF437R
19	NF469R	NF439R
19+	NF472R	NF442R
19++	NF473R	NF443R

Bicontact® revision aiming device

Basket tray with supports 540 x 254 x 56 mm	NF511R
Aiming arm	NF505P
Insertion instrument	NF504R
Screw measuring gauge	NF514R
2 drilling sleeves, ø 3.5 mm	NF506R
2 drilling sleeves, ø 5.0 mm	NF507R
Trocar	NF508R
Aiming gauge	NF509R
Drill, ø 3.5 mm	NF512R
Drill, ø 5.0 mm	NF513R

MFR medullary canal flexible reamer

Basket tray with lid 485 x 254 x 50 mm	NG865R*
Reamer head ø 11.5 mm	GE673R*
Reamer head ø 13 mm	GE676R*
Reamer head ø 14.5 mm	GE679R*
Reamer head ø 16 mm	GE682R*
Reamer head ø 17.5 mm	GE685R*

Reamer head ø 19 mm	GE688R*
MFR guide wire ø 2.5 mm L 800 mm	GE663S*
MFR Nitinol drill shaft, AO large shank	GE666R*
T-handle, canulated, AO large chuck	ND134R*

Recommended container for NF420, NF422 and NF510: AESCULAP® Basic Container 592 x 285 x 205 mm.

Instruments signed with a * please order separately.

AESCULAP® Bicontact®

IMPLANTS: Bicontact® PROSTHESIS STEMS

Bicontact® S and H

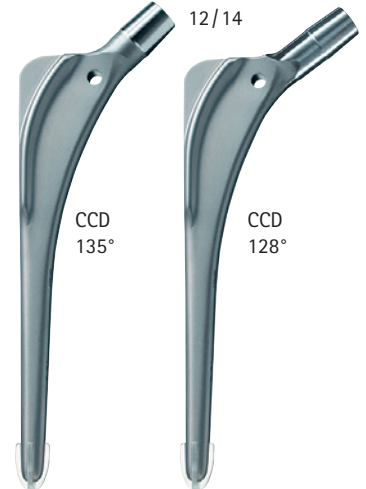

Cementless

	Bicontact® S	Bicontact® H		Bicontact® S	Bicontact® H
10	NK510T	NK110T	16	NK516T	NK116T
11	NK511T	NK111T	17	NK517T	NK117T
12	NK512T	NK112T	18	NK518T	NK118T
13	NK513T	NK113T	19	NK519T	NK119T
14	NK514T	NK114T	21	NK521T	NK121T
15	NK515T	NK115T			

Cemented with Centralizer

	Bicontact® S	Bicontact® H
10	NK610K	-
12	NK612K	NK312K
14	NK614K	NK314K
16	NK616K	NK316K
18	NK618K	NK318K

ISOTAN_F with Plasmapore®

ISODUR_F

The Bicontact® S hip stems have a 135° CCD angle and a linear progressing offset from 39.1 mm (size 10) to 50.1 mm (size 21). Bicontact® H implants (high offset) have an increased offset of 6 mm compared with Bicontact® S and a reduced CCD angle of 128°.

Recommended Centralizers for cemented Bicontact® prosthesis stems

	7 mm NK077	8 mm NK088	9 mm NK089	10 mm NK090	11 mm NK091	12 mm NK092	13 mm NK093	14 mm NK094	16 mm NK096
Bicontact® S	-	NK610K	-	NK612K	-	NK614K	-	NK616K	NK618K
Bicontact® H	-	NK310K	-	NK312K	-	NK314K	-	NK316K	NK318K

NOTE

The modular Centralizers can be combined with all cemented Bicontact® stems from size 8 on.

PMMA

Bicontact® SD



Bicontact® N



Cementless	
8	-
9	NK709T*
10	NK710T*
11	NK711T
12	NK712T
13	NK713T
14	NK714T
15	NK715T
16	NK716T

ISOTAN_F® with Plasmapore®

Cementless	
8	-
9	-
10	NJ010T
11	NJ011T
12	NJ012T
13	NJ013T
14	NJ014T
15	NJ015T
16	NJ016T

ISOTAN_F® with Plasmapore®

IMSET® plug	
8 mm	NK908
10 mm	NK910
12 mm	NK912
14 mm	NK914
16 mm	NK916
18 mm	NK918

Materials composition:
 50 % gelatin (from pigs),
 30 % glycerin,
 20 % water,
 2 ‰ methylparahydroxybenzonate

*NOTE

Weight limitation for the patient, see instructions for use for NK709T, NK710T.

NOTE

For Centralizer see left side.

AESCULAP® Bicontact®

IMPLANTS: Bicontact® PROSTHESIS STEMS

Bicontact® Revision

	220 – 250 mm straight	290 – 300 mm straight	290 – 300 mm right	290 – 300 mm left	distal diameter
11 SD	NK210T*	-	-	-	10.0 mm
11	NK211T	-	-	-	10.0 mm
13 SD	NK212T	-	-	-	11.5 mm
13	NK213T	-	-	-	11.5 mm
15	NK215T	NK235T	NK275T	NK375T	13.0 mm
17	NK217T	NK237T	NK277T	NK377T	14.5 mm
19	NK219T	NK239T	NK279T	NK379T	16.0 mm
19+	-	NK242T	NK282T	NK382T	17.5 mm
19++	-	NK243T	NK283T	NK383T	19.0 mm

ISOTAN®_F with Plasmapore®

*NOTE

Weight limitation for the patient, see instructions for use for NK210T.

	340 mm right	340 mm left	380 mm right	380 mm left	distal diameter
17	NK224T	NK334T	NK225T	NK335T	14.5 mm
19	NK226T	NK336T	NK227T	NK337T	16.0 mm
19+	NK228T	NK338T	NK229T	NK339T	17.5 mm
19++	NK230T	NK340T	NK231T	NK341T	19.0 mm

ISOTAN®_F with Plasmapore®



Bicontact® Revision Locking Screws

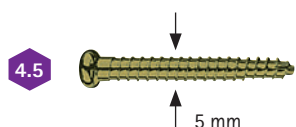

24 mm	28 mm	32 mm	36 mm	40 mm	44 mm	48 mm	52 mm	56 mm	60 mm
KB424TS	KB428TS	KB432TS	KB436TS	KB440TS	KB444TS	KB448TS	KB452TS	KB456TS	KB460TS

ISOTAN[®]_F

Implant materials:

ISOTAN [®] _F	Titanium forged alloy (Ti6Al4V/ISO 5832-3)
Plasmapore [®]	Pure titanium (Ti/ISO 5832-2)
ISODUR [®] _F	Cobalt-chromium forged alloy (CoCrMo/ISO 5832-12)
Bilox [®] forte	Aluminium oxide ceramic (Al ₂ O ₃ /ISO 6474-1)
Bilox [®] delta	Aluminium oxide matrix ceramic (Al ₂ O ₃ /ZrO ₂ /ISO 6474-2)

X-ray Templates Bicontact®

Please order separately:		Please order separately:	
Bicontact [®] S/H, cementless	ND746	Bicontact [®] Revision, AP, Sz. 11 – 15	NF454
Bicontact [®] S/H, cemented	ND747	Bicontact [®] Revision, ML, Sz. 11 – 15	NF455
Bicontact [®] SD, cementless	NF704	Bicontact [®] Revision, AP, Sz. 17 – 19++	NF456
Bicontact [®] N, cementless	NG207	Bicontact [®] Revision, ML, Sz. 17 – 19++	NF457
		Bicontact [®] Revision, AP, L: 340/380 mm	NF452
		Bicontact [®] Revision, ML, L: 340/380 mm	NF453
		Bicontact [®] Revision, AP/ML SD-Series	NF458

AESCULAP® Bicontact®

HIP ENDOPROSTHESIS HEADS 12/14



12/14

	28 mm	32 mm	36 mm	40 mm
short	NK460D	NK560D	NK650D	NK750D
medium	NK461D	NK561D	NK651D	NK751D
long	NK462D	NK562D	NK652D	NK752D
x-long	-	NK563D	NK653D	NK753D

Biolog® delta



12/14

	28 mm	32 mm	36 mm
short	-	NK560	NK650
medium	NK461	NK561	NK651
long	NK462	NK562	NK652
x-long	-	-	-

Biolog® forte



12/14

	22.2 mm	28 mm	32 mm	36 mm	40 mm	22.2 mm	28 mm	≥ 32 mm
short	-	NK429K	NK529K	NK669K	NK769K	-	- 3.5 mm	- 4.0 mm
medium	NK330K	NK430K	NK530K	NK670K	NK770K	± 0 mm	± 0 mm	± 0 mm
long	NK331K	NK431K	NK531K	NK671K	NK771K	+ 4.0 mm	+ 3.5 mm	+ 4.0 mm
x-long	-	NK432K	NK532K	NK672K	NK772K	-	+ 7.0 mm	+ 8.0 mm
xx-long	-	NK433K	NK533K	NK673K	NK773K	-	+ 10.5 mm	+ 12.0 mm

ISODUR®_F

Relative values for modular heads with cone 12/14.

Biolog® Option Heads



12/14

	28 mm	32 mm	36 mm
short	NK435	NK535	NK635
medium	NK436	NK536	NK636
long	NK437	NK537	NK637
x-long	NK438	NK538	NK638

Biolog® delta with sleeve Ti6Al4V

NOTE

Biolog® Option heads are delivered with a cone sleeve 12/14. For cone 8/10 please order the Biolog® Option sleeves showed on the right side.

HIP ENDOPROSTHESIS HEADS 8/10



8/10



8/10

	28 mm	32 mm	36 mm
short	NJ101D	NJ106D	NJ116D
medium	NJ102D	NJ107D	NJ117D
long	NJ103D	NJ108D	NJ118D
x-long	-	-	NJ119D

BioloX® delta

	22.2 mm	28 mm	32 mm
short	NJ081	-	-
medium	NJ082	-	-
long	-	-	-
x-long	-	-	-

BioloX® forte



8/10

	22.2 mm	28 mm	32 mm	36 mm	40 mm	22.2 mm	28 mm	≥ 32 mm
short	NJ111K	NJ131K	NJ126K	NJ136K	-	- 3.5 mm	- 3.5 mm	- 3.5 mm
medium	NJ112K	NJ132K	NJ127K	NJ137K	-	± 0 mm	± 0 mm	± 0 mm
long	NJ113K	NJ133K	NJ128K	NJ138K	-	+ 3.5 mm	+ 3.5 mm	+ 3.5 mm
x-long	-	NJ134K	NJ129K	NJ139K	-	-	+ 7.0 mm	+ 7.0 mm
xx-long	-	NJ135K	NJ130K	NJ140K	-	-	+ 10.5 mm	+ 10.5 mm

ISODUR®_F

Relative values for modular heads with cone 8/10.

BioloX® Option Sleeves for 8/10 Cones



8/10

short	medium	long	x-long
NJ435T	NJ436T	NJ437T	NJ438T

Ti6Al4V

AESFULAP® – a B. Braun brand

Aesculap AG | Am Aesculap-Platz | 78532 Tuttlingen | Germany
Phone +49 7461 95-0 | Fax +49 7461 95-2600 | www.aesculap.com

The main product trademark "Aesculap" and the product trademarks "Bicontact", "IMSET", "ISODUR", "ISOTAN", "OrthoPilot", "Plasmacup" and "Plasmapore" are registered trademarks of Aesculap AG.
"BioloX" is a registered trademark of CeramTec GmbH, Plochingen.

Subject to technical changes. All rights reserved. This brochure may only be used for the exclusive purpose of obtaining information about our products. Reproduction in any form partial or otherwise is not permitted.