

Aesculap[®] e.motion[®]

Knee Endoprosthesis System – Ordering information
Knieendoprothesen System – Bestellinformation



Aesculap Orthopaedics

Overview Übersicht

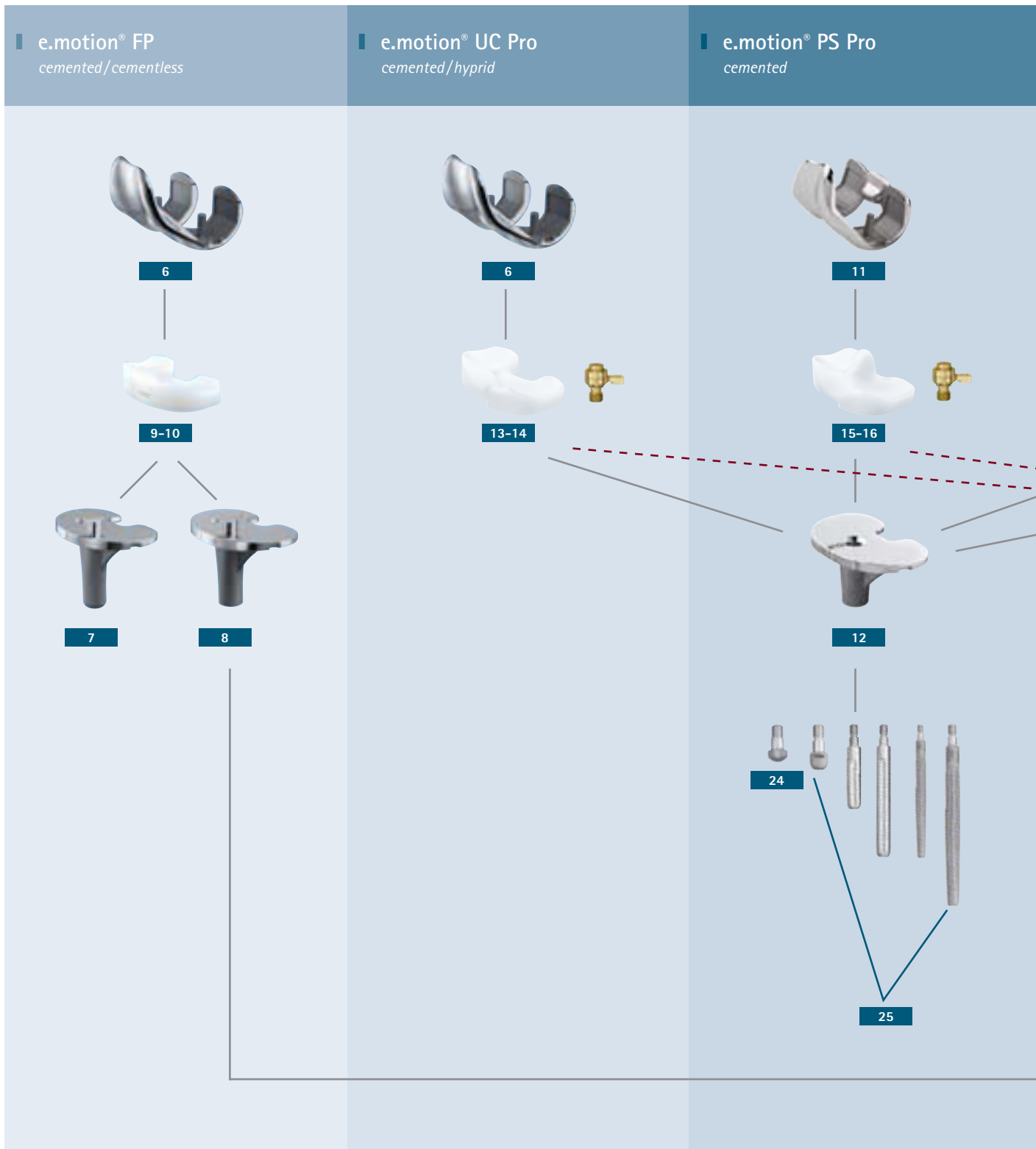

e.motion® UC Standard
cemented/hybrid

e.motion® PS/Revision
cemented/cementless



6



20-21



18



23-24



28-30



31-32



19



26-27

The rotation peg without stop is needed:
NB800Z – NB870Z (PS)
NR801R – NR851Z (UC)

17



24

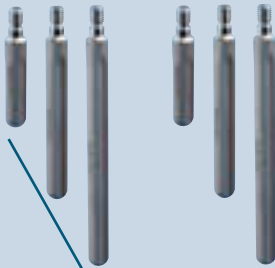

24-25

Implant System Implantat System

	Set No.	Container recommended	Lid	Height of tray incl. lid /mm	
e.motion® FP					
NS700	NS701	IQ e.motion® Set General Instruments	JK441	JK498	118.2
	NS702	IQ e.motion® Set Tibia Instruments	JK441	JK498	118.2
	NS703	IQ e.motion® Set Femur Preparation	JK440	JK498	88.2
	NS705	IQ e.motion® Set Tibia Preparation + UC Trials	JK441	JK498	118.2
	NS706	IQ e.motion® Set Femur UC Trial Implants	JK441	JK498	118.2
	NS704	IQ e.motion® Set Trial Meniscal Components FP	JK440	JK498	68.7
e.motion® UC					
NS700	NS701	IQ e.motion® Set General Instruments	JK441	JK498	118.2
	NS702	IQ e.motion® Set Tibia Instruments	JK441	JK498	118.2
	NS703	IQ e.motion® Set Femur Preparation	JK440	JK498	88.2
	NS705	IQ e.motion® Set Tibia Preparation + UC Trials	JK441	JK498	118.2
	NS706	IQ e.motion® Set Femur UC Trial Implants	JK441	JK498	118.2
e.motion® PS					
NS700	NS701	IQ e.motion® Set General Instruments	JK441	JK498	118.2
	NS702	IQ e.motion® Set Tibia Instruments	JK441	JK498	118.2
	NS703	IQ e.motion® Set Femur Preparation	JK440	JK498	88.2
	NS705	IQ e.motion® Set Tibia Preparation + UC Trials	JK441	JK498	118.2
	NS706	IQ e.motion® Set Femur UC Trial Implants	JK441	JK498	118.2
	NS707	IQ e.motion® Set PS Instruments	JK441	JK498	118.7
NS730	IQ e.motion® Set Trial Meniscal Components PS	JK440	JK498	68.7	
e.motion® UC Pro					
NS760	NS701	IQ e.motion® Set General Instruments	JK441	JK498	118.2
	NS702	IQ e.motion® Set Tibia Instruments	JK441	JK498	118.2
	NS703	IQ e.motion® Set Femur Preparation	JK440	JK498	88.2
	NS856	IQ e.motion® Pro Set Tibia Preparation + UC Trials	JK441	JK498	118.2
	NS706	IQ e.motion® Set Femur UC Trial Implants	JK441	JK498	118.2
e.motion® PS Pro					
	NS701	IQ e.motion® Set General Instruments	JK441	JK498	118.2
	NS702	IQ e.motion® Set Tibia Instruments	JK441	JK498	118.2
	NS703	IQ e.motion® Set Femur Preparation	JK440	JK498	88.2
	NS856	IQ e.motion® Pro Set Tibia Preparation + UC Trials	JK441	JK498	118.2
	NS770	IQ e.motion® PS Pro Set Femur Trial Implants + Preparation	JK442	JK498	121.2
	NS780	IQ e.motion® PS Pro Set Trial Meniscal Components	JK440	JK498	68.7

	Set No.	Container recommended	Lid	Height of tray incl. lid /mm	
e.motion® Revision					
NS700	NS701	IQ e.motion® Set General Instruments	JK441	JK498	118.2
	NS702	IQ e.motion® Set Tibia Instruments	JK441	JK498	118.2
	NS703	IQ e.motion® Set Femur Preparation	JK440	JK498	88.2
	NS705	IQ e.motion® Set Tibia Preparation + UC Trials	JK441	JK498	118.2
	NS706	IQ e.motion® Set Femur UC Trial Implants	JK441	JK498	118.2
	NS707	IQ e.motion® Set PS Instruments	JK441	JK498	118.7
	NS730	IQ e.motion® Set Trial Meniscal Components PS	JK440	JK498	68.7
	NS708	IQ e.motion® Set Tibia Extension Stems	JK440	JK498	88.2
NM150	NM398	Femur Stem Preparation Instruments	JK444	JK498	76
	NM454	Instruments and Trial Implants	JK444	JK498	76
	NM458	Femur Preparation Instruments	JK444	JK498	76
	NM396	Trial Femur Augments 12 mm	JK444	JK498	76
	NM982*	Tibia Preparation Instruments	JK444	JK498	76
	NM984*	Trial Tibia Components handles NE380R + NE510R	JK444	JK498	76

*These two instrument sets are needed until trial augments are available for IQ platform tibia preparation

Optional Sets

e.motion® Tibia Extension Stems (only for FP, UC, PS, Revision)

	NS708	IQ e.motion® Set Tibia Extension Stems	JK440	JK498	88.2
--	-------	--	-------	-------	------

General Tibia Extension Stems (only for UC Pro, PS Pro)

	NS858	IQ Set Tibia Extension Stems	JK441	JK498	91.2
--	-------	------------------------------	-------	-------	------

e.motion® PS Pro Trial Femur Standard Sizes

	NS768	IQ e.motion® PS Pro Set Femur Trial Implants Standard Sizes	JK441	JK498	118.2
--	-------	---	-------	-------	-------

Patella

	NS709	IQ Set Patella Instruments	JK441	JK498	118.2
--	-------	----------------------------	-------	-------	-------

Navigation

	NS720	IQ Set Navigation Instruments	JK441	JK498	118.2
	FS235	Software TKA Version 5			
	FS228	Software TKA Smart			

X-ray Templates

	NE398	FP/UC/PS Femur – FP/UC/PS Tibia – Revision – e.motion® stems			1.10:1
	NE399	FP/UC/PS Femur – FP/UC/PS Tibia – Revision – e.motion® stems			1.15:1
	NS416	PS Pro Femur – PS Pro/UC Pro Tibia – general stems			1.10:1
	NS417	PS Pro Femur – PS Pro/UC Pro Tibia – general stems			1.15:1

Aesculap® e.motion®

Femur FP/UC

cemented – zementiert

Art No.	Description	
left – links		
Standard-Version		AS-Version
N0502K	e.motion® FP Femur F2L	N0502Z
N0503K	e.motion® FP Femur F3L	N0503Z
N0504K	e.motion® FP Femur F4L	N0504Z
N0505K	e.motion® FP Femur F5L	N0505Z
N0506K	e.motion® FP Femur F6L	N0506Z
N0507K	e.motion® FP Femur F7L	N0507Z
N0508K	e.motion® FP Femur F8L	N0508Z
right – rechts		
N0602K	e.motion® FP Femur F2R	N0602Z
N0603K	e.motion® FP Femur F3R	N0603Z
N0604K	e.motion® FP Femur F4R	N0604Z
N0605K	e.motion® FP Femur F5R	N0605Z
N0606K	e.motion® FP Femur F6R	N0606Z
N0607K	e.motion® FP Femur F7R	N0607Z
N0608K	e.motion® FP Femur F8R	N0608Z



ISODUR[®]C

Femur FP/UC

cementless – zementfrei

Art No.	Description
left – links	
N0582K	e.motion® FP Femur F2L
N0583K	e.motion® FP Femur F3L
N0584K	e.motion® FP Femur F4L
N0585K	e.motion® FP Femur F5L
N0586K	e.motion® FP Femur F6L
N0587K	e.motion® FP Femur F7L
N0588K	e.motion® FP Femur F8L
right – rechts	
N0682K	e.motion® FP Femur F2R
N0683K	e.motion® FP Femur F3R
N0684K	e.motion® FP Femur F4R
N0685K	e.motion® FP Femur F5R
N0686K	e.motion® FP Femur F6R
N0687K	e.motion® FP Femur F7R
N0688K	e.motion® FP Femur F8R



ISODUR[®]C
Plasmapore® μ-CaP

Monobloc Tibia Plateau FP

cemented – zementiert

Art No.	Description
left – links	
N0521K	e.motion® FP Tibial Plateau T1L
N0522K	e.motion® FP Tibial Plateau T2L
N0523K	e.motion® FP Tibial Plateau T3L
N0524K	e.motion® FP Tibial Plateau T4L
N0525K	e.motion® FP Tibial Plateau T5L
N0526K	e.motion® FP Tibial Plateau T6L
N0527K	e.motion® FP Tibial Plateau T7L
N0528K	e.motion® FP Tibial Plateau T8L
right – rechts	
N0621K	e.motion® FP Tibial Plateau T1R
N0622K	e.motion® FP Tibial Plateau T2R
N0623K	e.motion® FP Tibial Plateau T3R
N0624K	e.motion® FP Tibial Plateau T4R
N0625K	e.motion® FP Tibial Plateau T5R
N0626K	e.motion® FP Tibial Plateau T6R
N0627K	e.motion® FP Tibial Plateau T7R
N0628K	e.motion® FP Tibial Plateau T8R



ISODUR[®]C

Modular Tibia Plateau FP

cemented – zementiert

Art No.	Description	
left – links		
Standard-Version		AS-Version
NB521K	e.motion® FP Tibia Plateau T1L	NB521Z
NB522K	e.motion® FP Tibia Plateau T2L	NB522Z
NB523K	e.motion® FP Tibia Plateau T3L	NB523Z
NB524K	e.motion® FP Tibia Plateau T4L	NB524Z
NB525K	e.motion® FP Tibia Plateau T5L	NB525Z
NB526K	e.motion® FP Tibia Plateau T6L	NB526Z
NB527K	e.motion® FP Tibia Plateau T7L	NB527Z
NB528K	e.motion® FP Tibia Plateau T8L	NB528Z
right – rechts		
NB621K	e.motion® FP Tibia Plateau T1R	NB621Z
NB622K	e.motion® FP Tibia Plateau T2R	NB622Z
NB623K	e.motion® FP Tibia Plateau T3R	NB623Z
NB624K	e.motion® FP Tibia Plateau T4R	NB624Z
NB625K	e.motion® FP Tibia Plateau T5R	NB625Z
NB626K	e.motion® FP Tibia Plateau T6R	NB626Z
NB627K	e.motion® FP Tibia Plateau T7R	NB627Z
NB628K	e.motion® FP Tibia Plateau T8R	NB628Z



ISODUR[®]_C

Modular Tibia Plateau FP

cementless – zementfrei

Art No.	Description
left – links	
NB591K	e.motion® FP Tibia Plateau T1L
NB592K	e.motion® FP Tibia Plateau T2L
NB593K	e.motion® FP Tibia Plateau T3L
NB594K	e.motion® FP Tibia Plateau T4L
NB595K	e.motion® FP Tibia Plateau T5L
NB596K	e.motion® FP Tibia Plateau T6L
NB597K	e.motion® FP Tibia Plateau T7L
NB598K	e.motion® FP Tibia Plateau T8L
right – rechts	
NB691K	e.motion® FP Tibia Plateau T1R
NB692K	e.motion® FP Tibia Plateau T2R
NB693K	e.motion® FP Tibia Plateau T3R
NB694K	e.motion® FP Tibia Plateau T4R
NB695K	e.motion® FP Tibia Plateau T5R
NB696K	e.motion® FP Tibia Plateau T6R
NB697K	e.motion® FP Tibia Plateau T7R
NB698K	e.motion® FP Tibia Plateau T8R



ISODUR[®]_C
Plasmapore® μ-CaP

Meniscal Component FP

Meniscal Component – Meniskuskomponente

Art No.	Description	
left – links		
10 mm		12 mm
N0542	e.motion® FP Meniscal Component F2L	N0552
N0543	e.motion® FP Meniscal Component F3L	N0553
N0544	e.motion® FP Meniscal Component F4L	N0554
N0545	e.motion® FP Meniscal Component F5L	N0555
N0546	e.motion® FP Meniscal Component F6L	N0556
N0547	e.motion® FP Meniscal Component F7L	N0557
N0548	e.motion® FP Meniscal Component F8L	N0558
14 mm		16 mm
N0562	e.motion® FP Meniscal Component F2L	N0572
N0563	e.motion® FP Meniscal Component F3L	N0573
N0564	e.motion® FP Meniscal Component F4L	N0574
N0565	e.motion® FP Meniscal Component F5L	N0575
N0566	e.motion® FP Meniscal Component F6L	N0576
N0567	e.motion® FP Meniscal Component F7L	N0577
N0568	e.motion® FP Meniscal Component F8L	N0578
18 mm		20 mm
N0592	e.motion® FP Meniscal Component F2L	N0782
N0593	e.motion® FP Meniscal Component F3L	N0783
N0594	e.motion® FP Meniscal Component F4L	N0784
N0595	e.motion® FP Meniscal Component F5L	N0785
N0596	e.motion® FP Meniscal Component F6L	N0786
N0597	e.motion® FP Meniscal Component F7L	N0787
N0598	e.motion® FP Meniscal Component F8L	N0788



UHMWPE

Meniscal Component FP

Meniscal Component – Meniskuskomponente

Art No.	Description	
right – rechts		
10 mm		12 mm
N0642	e.motion® FP Meniscal Component F2R	N0652
N0643	e.motion® FP Meniscal Component F3R	N0653
N0644	e.motion® FP Meniscal Component F4R	N0654
N0645	e.motion® FP Meniscal Component F5R	N0655
N0646	e.motion® FP Meniscal Component F6R	N0656
N0647	e.motion® FP Meniscal Component F7R	N0657
N0648	e.motion® FP Meniscal Component F8R	N0658
14 mm		16 mm
N0662	e.motion® FP Meniscal Component F2R	N0672
N0663	e.motion® FP Meniscal Component F3R	N0673
N0664	e.motion® FP Meniscal Component F4R	N0674
N0665	e.motion® FP Meniscal Component F5R	N0675
N0666	e.motion® FP Meniscal Component F6R	N0676
N0667	e.motion® FP Meniscal Component F7R	N0677
N0668	e.motion® FP Meniscal Component F8R	N0678
18 mm		20 mm
N0692	e.motion® FP Meniscal Component F2R	N0792
N0693	e.motion® FP Meniscal Component F3R	N0793
N0694	e.motion® FP Meniscal Component F4R	N0794
N0695	e.motion® FP Meniscal Component F5R	N0795
N0696	e.motion® FP Meniscal Component F6R	N0796
N0697	e.motion® FP Meniscal Component F7R	N0797
N0698	e.motion® FP Meniscal Component F8R	N0798



UHMWPE

Femur PS Pro

cemented – zementiert

Art No.	Description	
Standard-Version		AS-Version
10 mm		
NX700K	e.motion® PS Pro Femur F2L	NX700Z
NX701K	e.motion® PS Pro Femur F3L	NX701Z
NX702K	e.motion® PS Pro Femur F4NL	NX702Z
NX703K	e.motion® PS Pro Femur F4L	NX703Z
NX704K	e.motion® PS Pro Femur F5NL	NX704Z
NX705K	e.motion® PS Pro Femur F5L	NX705Z
NX706K	e.motion® PS Pro Femur F6NL	NX706Z
NX707K	e.motion® PS Pro Femur F6L	NX707Z
NX708K	e.motion® PS Pro Femur F7L	NX708Z
NX709K	e.motion® PS Pro Femur F8L	NX709Z
NX750K	e.motion® PS Pro Femur F2R	NX750Z
NX751K	e.motion® PS Pro Femur F3R	NX751Z
NX752K	e.motion® PS Pro Femur F4NR	NX752Z
NX753K	e.motion® PS Pro Femur F4R	NX753Z
NX754K	e.motion® PS Pro Femur F5NR	NX754Z
NX755K	e.motion® PS Pro Femur F5R	NX755Z
NX756K	e.motion® PS Pro Femur F6NR	NX756Z
NX757K	e.motion® PS Pro Femur F6R	NX757Z
NX758K	e.motion® PS Pro Femur F7R	NX758Z
NX759K	e.motion® PS Pro Femur F8R	NX759Z



ISODUR^c

Modular Tibia Plateau UC Pro with safety stop

cemented – zementiert

Art No.	Description	AS-Version
Standard-Version		AS-Version
NX731K	e.motion® PRO Tibia Plateau T1L	NX731Z
NX732K	e.motion® PRO Tibia Plateau T2L	NX732Z
NX733K	e.motion® PRO Tibia Plateau T3L	NX733Z
NX734K	e.motion® PRO Tibia Plateau T4L	NX734Z
NX735K	e.motion® PRO Tibia Plateau T5L	NX735Z
NX736K	e.motion® PRO Tibia Plateau T6L	NX736Z
NX737K	e.motion® PRO Tibia Plateau T7L	NX737Z
NX738K	e.motion® PRO Tibia Plateau T8L	NX738Z
NX781K	e.motion® PRO Tibia Plateau T1R	NX781Z
NX782K	e.motion® PRO Tibia Plateau T2R	NX782Z
NX783K	e.motion® PRO Tibia Plateau T3R	NX783Z
NX784K	e.motion® PRO Tibia Plateau T4R	NX784Z
NX785K	e.motion® PRO Tibia Plateau T5R	NX785Z
NX786K	e.motion® PRO Tibia Plateau T6R	NX786Z
NX787K	e.motion® PRO Tibia Plateau T7R	NX787Z
NX788K	e.motion® PRO Tibia Plateau T8R	NX788Z



Meniscal Component UC Pro with safety stop

Meniscal Component – Meniskuskomponente

Art No.	Description	
left – links		
NX402	e.motion® UC Pro Meniscal Component F2L	10 mm
NX403	e.motion® UC Pro Meniscal Component F3L	10 mm
NX404	e.motion® UC Pro Meniscal Component F4L	10 mm
NX405	e.motion® UC Pro Meniscal Component F5L	10 mm
NX406	e.motion® UC Pro Meniscal Component F6L	10 mm
NX407	e.motion® UC Pro Meniscal Component F7L	10 mm
NX408	e.motion® UC Pro Meniscal Component F8L	10 mm
NX412	e.motion® UC Pro Meniscal Component F2L	12 mm
NX413	e.motion® UC Pro Meniscal Component F3L	12 mm
NX414	e.motion® UC Pro Meniscal Component F4L	12 mm
NX415	e.motion® UC Pro Meniscal Component F5L	12 mm
NX416	e.motion® UC Pro Meniscal Component F6L	12 mm
NX417	e.motion® UC Pro Meniscal Component F7L	12 mm
NX418	e.motion® UC Pro Meniscal Component F8L	12 mm
NX422	e.motion® UC Pro Meniscal Component F2L	14 mm
NX423	e.motion® UC Pro Meniscal Component F3L	14 mm
NX424	e.motion® UC Pro Meniscal Component F4L	14 mm
NX425	e.motion® UC Pro Meniscal Component F5L	14 mm
NX426	e.motion® UC Pro Meniscal Component F6L	14 mm
NX427	e.motion® UC Pro Meniscal Component F7L	14 mm
NX428	e.motion® UC Pro Meniscal Component F8L	14 mm
NX432	e.motion® UC Pro Meniscal Component F2L	16 mm
NX433	e.motion® UC Pro Meniscal Component F3L	16 mm
NX434	e.motion® UC Pro Meniscal Component F4L	16 mm
NX435	e.motion® UC Pro Meniscal Component F5L	16 mm
NX436	e.motion® UC Pro Meniscal Component F6L	16 mm
NX437	e.motion® UC Pro Meniscal Component F7L	16 mm
NX438	e.motion® UC Pro Meniscal Component F8L	16 mm
NX442	e.motion® UC Pro Meniscal Component F2L	18 mm
NX443	e.motion® UC Pro Meniscal Component F3L	18 mm
NX444	e.motion® UC Pro Meniscal Component F4L	18 mm
NX445	e.motion® UC Pro Meniscal Component F5L	18 mm
NX446	e.motion® UC Pro Meniscal Component F6L	18 mm
NX447	e.motion® UC Pro Meniscal Component F7L	18 mm
NX448	e.motion® UC Pro Meniscal Component F8L	18 mm
NX452	e.motion® UC Pro Meniscal Component F2L	20 mm
NX453	e.motion® UC Pro Meniscal Component F3L	20 mm
NX454	e.motion® UC Pro Meniscal Component F4L	20 mm
NX455	e.motion® UC Pro Meniscal Component F5L	20 mm
NX456	e.motion® UC Pro Meniscal Component F6L	20 mm
NX457	e.motion® UC Pro Meniscal Component F7L	20 mm
NX458	e.motion® UC Pro Meniscal Component F8L	20 mm



UHMWPE

Meniscal Component UC Pro with safety stop

Meniscal Component – Meniskuskomponente

Art. No.	Description	
right – rechts		
NX502	e.motion® UC Pro Meniscal Component F2R	10 mm
NX503	e.motion® UC Pro Meniscal Component F3R	10 mm
NX504	e.motion® UC Pro Meniscal Component F4R	10 mm
NX505	e.motion® UC Pro Meniscal Component F5R	10 mm
NX506	e.motion® UC Pro Meniscal Component F6R	10 mm
NX507	e.motion® UC Pro Meniscal Component F7R	10 mm
NX508	e.motion® UC Pro Meniscal Component F8R	10 mm
NX512	e.motion® UC Pro Meniscal Component F2R	12 mm
NX513	e.motion® UC Pro Meniscal Component F3R	12 mm
NX514	e.motion® UC Pro Meniscal Component F4R	12 mm
NX515	e.motion® UC Pro Meniscal Component F5R	12 mm
NX516	e.motion® UC Pro Meniscal Component F6R	12 mm
NX517	e.motion® UC Pro Meniscal Component F7R	12 mm
NX518	e.motion® UC Pro Meniscal Component F8R	12 mm
NX522	e.motion® UC Pro Meniscal Component F2R	14 mm
NX523	e.motion® UC Pro Meniscal Component F3R	14 mm
NX524	e.motion® UC Pro Meniscal Component F4R	14 mm
NX525	e.motion® UC Pro Meniscal Component F5R	14 mm
NX526	e.motion® UC Pro Meniscal Component F6R	14 mm
NX527	e.motion® UC Pro Meniscal Component F7R	14 mm
NX528	e.motion® UC Pro Meniscal Component F8R	14 mm
NX532	e.motion® UC Pro Meniscal Component F2R	16 mm
NX533	e.motion® UC Pro Meniscal Component F3R	16 mm
NX534	e.motion® UC Pro Meniscal Component F4R	16 mm
NX535	e.motion® UC Pro Meniscal Component F5R	16 mm
NX536	e.motion® UC Pro Meniscal Component F6R	16 mm
NX537	e.motion® UC Pro Meniscal Component F7R	16 mm
NX538	e.motion® UC Pro Meniscal Component F8R	16 mm
NX542	e.motion® UC Pro Meniscal Component F2R	18 mm
NX543	e.motion® UC Pro Meniscal Component F3R	18 mm
NX544	e.motion® UC Pro Meniscal Component F4R	18 mm
NX545	e.motion® UC Pro Meniscal Component F5R	18 mm
NX546	e.motion® UC Pro Meniscal Component F6R	18 mm
NX547	e.motion® UC Pro Meniscal Component F7R	18 mm
NX548	e.motion® UC Pro Meniscal Component F8R	18 mm
NX552	e.motion® UC Pro Meniscal Component F2R	20 mm
NX553	e.motion® UC Pro Meniscal Component F3R	20 mm
NX554	e.motion® UC Pro Meniscal Component F4R	20 mm
NX555	e.motion® UC Pro Meniscal Component F5R	20 mm
NX556	e.motion® UC Pro Meniscal Component F6R	20 mm
NX557	e.motion® UC Pro Meniscal Component F7R	20 mm
NX558	e.motion® UC Pro Meniscal Component F8R	20 mm



UHMWPE

Meniscal Component PS Pro with safety stop

Meniscal Component – Meniskuskomponente

Art. No.	Description	
left – links		
NX802	e.motion® PS Pro Meniscal Component F2L	10 mm
NX803	e.motion® PS Pro Meniscal Component F3L	10 mm
NX804	e.motion® PS Pro Meniscal Component F4L	10 mm
NX805	e.motion® PS Pro Meniscal Component F5L	10 mm
NX806	e.motion® PS Pro Meniscal Component F6L	10 mm
NX807	e.motion® PS Pro Meniscal Component F7L	10 mm
NX808	e.motion® PS Pro Meniscal Component F8L	10 mm
NX812	e.motion® PS Pro Meniscal Component F2L	12 mm
NX813	e.motion® PS Pro Meniscal Component F3L	12 mm
NX814	e.motion® PS Pro Meniscal Component F4L	12 mm
NX815	e.motion® PS Pro Meniscal Component F5L	12 mm
NX816	e.motion® PS Pro Meniscal Component F6L	12 mm
NX817	e.motion® PS Pro Meniscal Component F7L	12 mm
NX818	e.motion® PS Pro Meniscal Component F8L	12 mm
NX822	e.motion® PS Pro Meniscal Component F2L	14 mm
NX823	e.motion® PS Pro Meniscal Component F3L	14 mm
NX824	e.motion® PS Pro Meniscal Component F4L	14 mm
NX825	e.motion® PS Pro Meniscal Component F5L	14 mm
NX826	e.motion® PS Pro Meniscal Component F6L	14 mm
NX827	e.motion® PS Pro Meniscal Component F7L	14 mm
NX828	e.motion® PS Pro Meniscal Component F8L	14 mm
NX832	e.motion® PS Pro Meniscal Component F2L	16 mm
NX833	e.motion® PS Pro Meniscal Component F3L	16 mm
NX834	e.motion® PS Pro Meniscal Component F4L	16 mm
NX835	e.motion® PS Pro Meniscal Component F5L	16 mm
NX836	e.motion® PS Pro Meniscal Component F6L	16 mm
NX837	e.motion® PS Pro Meniscal Component F7L	16 mm
NX838	e.motion® PS Pro Meniscal Component F8L	16 mm
NX842	e.motion® PS Pro Meniscal Component F2L	18 mm
NX843	e.motion® PS Pro Meniscal Component F3L	18 mm
NX844	e.motion® PS Pro Meniscal Component F4L	18 mm
NX845	e.motion® PS Pro Meniscal Component F5L	18 mm
NX846	e.motion® PS Pro Meniscal Component F6L	18 mm
NX847	e.motion® PS Pro Meniscal Component F7L	18 mm
NX848	e.motion® PS Pro Meniscal Component F8L	18 mm
NX852	e.motion® PS Pro Meniscal Component F2L	20 mm
NX853	e.motion® PS Pro Meniscal Component F3L	20 mm
NX854	e.motion® PS Pro Meniscal Component F4L	20 mm
NX855	e.motion® PS Pro Meniscal Component F5L	20 mm
NX856	e.motion® PS Pro Meniscal Component F6L	20 mm
NX857	e.motion® PS Pro Meniscal Component F7L	20 mm
NX858	e.motion® PS Pro Meniscal Component F8L	20 mm



UHMWPE

Meniscal Component PS Pro with safety stop

Meniscal Component – Meniskuskomponente

Art. No.	Description	
right – rechts		
NX902	e.motion® PS Pro Meniscal Component F2R	10 mm
NX903	e.motion® PS Pro Meniscal Component F3R	10 mm
NX904	e.motion® PS Pro Meniscal Component F4R	10 mm
NX905	e.motion® PS Pro Meniscal Component F5R	10 mm
NX906	e.motion® PS Pro Meniscal Component F6R	10 mm
NX907	e.motion® PS Pro Meniscal Component F7R	10 mm
NX908	e.motion® PS Pro Meniscal Component F8R	10 mm
NX912	e.motion® PS Pro Meniscal Component F2R	12 mm
NX913	e.motion® PS Pro Meniscal Component F3R	12 mm
NX914	e.motion® PS Pro Meniscal Component F4R	12 mm
NX915	e.motion® PS Pro Meniscal Component F5R	12 mm
NX916	e.motion® PS Pro Meniscal Component F6R	12 mm
NX917	e.motion® PS Pro Meniscal Component F7R	12 mm
NX918	e.motion® PS Pro Meniscal Component F8R	12 mm
NX922	e.motion® PS Pro Meniscal Component F2R	14 mm
NX923	e.motion® PS Pro Meniscal Component F3R	14 mm
NX924	e.motion® PS Pro Meniscal Component F4R	14 mm
NX925	e.motion® PS Pro Meniscal Component F5R	14 mm
NX926	e.motion® PS Pro Meniscal Component F6R	14 mm
NX927	e.motion® PS Pro Meniscal Component F7R	14 mm
NX928	e.motion® PS Pro Meniscal Component F8R	14 mm
NX932	e.motion® PS Pro Meniscal Component F2R	16 mm
NX933	e.motion® PS Pro Meniscal Component F3R	16 mm
NX934	e.motion® PS Pro Meniscal Component F4R	16 mm
NX935	e.motion® PS Pro Meniscal Component F5R	16 mm
NX936	e.motion® PS Pro Meniscal Component F6R	16 mm
NX937	e.motion® PS Pro Meniscal Component F7R	16 mm
NX938	e.motion® PS Pro Meniscal Component F8R	16 mm
NX942	e.motion® PS Pro Meniscal Component F2R	18 mm
NX943	e.motion® PS Pro Meniscal Component F3R	18 mm
NX944	e.motion® PS Pro Meniscal Component F4R	18 mm
NX945	e.motion® PS Pro Meniscal Component F5R	18 mm
NX946	e.motion® PS Pro Meniscal Component F6R	18 mm
NX947	e.motion® PS Pro Meniscal Component F7R	18 mm
NX948	e.motion® PS Pro Meniscal Component F8R	18 mm
NX952	e.motion® PS Pro Meniscal Component F2R	20 mm
NX953	e.motion® PS Pro Meniscal Component F3R	20 mm
NX954	e.motion® PS Pro Meniscal Component F4R	20 mm
NX955	e.motion® PS Pro Meniscal Component F5R	20 mm
NX956	e.motion® PS Pro Meniscal Component F6R	20 mm
NX957	e.motion® PS Pro Meniscal Component F7R	20 mm
NX958	e.motion® PS Pro Meniscal Component F8R	20 mm



UHMWPE

Rotation Axis without stop for tibia component UC Pro / PS Pro, SW4.5

Rotation Axis – Rotationsachse

Art. No.	Description
NB800Z	Tibia Plateau Peg AS SW4.5 10 mm PS
NB810Z	Tibia Plateau Peg AS SW4.5 12 mm PS
NB820Z	Tibia Plateau Peg AS SW4.5 14 mm PS
NB830Z	Tibia Plateau Peg AS SW4.5 16 mm PS
NB840Z	Tibia Plateau Peg AS SW4.5 18 mm PS
NB850Z	Tibia Plateau Peg AS SW4.5 20 mm PS
NB860Z	Tibia Plateau Peg AS SW4.5 22 mm PS
NB870Z	Tibia Plateau Peg AS SW4.5 24 mm PS
NR801Z	Tibia Plateau Peg AS SW4.5 10 mm UC
NR811Z	Tibia Plateau Peg AS SW4.5 12 mm UC
NR821Z	Tibia Plateau Peg AS SW4.5 14 mm UC
NR831Z	Tibia Plateau Peg AS SW4.5 16 mm UC
NR841Z	Tibia Plateau Peg AS SW4.5 18 mm UC
NR851Z	Tibia Plateau Peg AS SW4.5 20 mm UC
NP450R	Torque wrench adapter SW4.5



ISODUR_F

Rotation Axis for tibia component UC / PS, SW3.5

Rotation Axis – Rotationsachse

Art. No.	Description
NB900Z	Tibia Plateau Peg AS SW3.5 10 mm PS
NB910Z	Tibia Plateau Peg AS SW3.5 12 mm PS
NB920Z	Tibia Plateau Peg AS SW3.5 14 mm PS
NB930Z	Tibia Plateau Peg AS SW3.5 16 mm PS
NB940Z	Tibia Plateau Peg AS SW3.5 18 mm PS
NB950Z	Tibia Plateau Peg AS SW3.5 20 mm PS
NB960Z	Tibia Plateau Peg AS SW3.5 22 mm PS
NB970Z	Tibia Plateau Peg AS SW3.5 24 mm PS
NR900Z	Tibia Plateau Peg AS SW3.5 10 mm UC
NR910Z	Tibia Plateau Peg AS SW3.5 12 mm UC
NR920Z	Tibia Plateau Peg AS SW3.5 14 mm UC
NR930Z	Tibia Plateau Peg AS SW3.5 16 mm UC
NR940Z	Tibia Plateau Peg AS SW3.5 18 mm UC
NR950Z	Tibia Plateau Peg AS SW3.5 20 mm UC
NQ658R	Torque wrench adapter SW3.5



ISODUR_F

Aesculap® e.motion®

Femur PS

cemented – zementiert

Art No.	Description	
left – links		
Standard-Version		AS-Version
NB702K	e.motion® PS Femur F2L	NB702Z
NB703K	e.motion® PS Femur F3L	NB703Z
NB704K	e.motion® PS Femur F4L	NB704Z
NB705K	e.motion® PS Femur F5L	NB706Z
NB706K	e.motion® PS Femur F6L	NB706Z
NB707K	e.motion® PS Femur F7L	NB707Z
NB708K	e.motion® PS Femur F8L	NB708Z
right – rechts		
NB752K	e.motion® PS Femur F2R	NB752Z
NB753K	e.motion® PS Femur F3R	NB753Z
NB754K	e.motion® PS Femur F4R	NB754Z
NB755K	e.motion® PS Femur F5R	NB755Z
NB756K	e.motion® PS Femur F6R	NB756Z
NB757K	e.motion® PS Femur F7R	NB757Z
NB758K	e.motion® PS Femur F8R	NB758Z
NB700P	e.motion® PS cover for femur box	



ISODUR[®]



NB700P
PEEK-OPTIMA[®]

Femur PS

cementless – zementfrei

Art No.	Description
left – links	
NB712K	e.motion® PS Femur F2L
NB713K	e.motion® PS Femur F3L
NB714K	e.motion® PS Femur F4L
NB715K	e.motion® PS Femur F5L
NB716K	e.motion® PS Femur F6L
NB717K	e.motion® PS Femur F7L
NB718K	e.motion® PS Femur F8L
right – rechts	
NB762K	e.motion® PS Femur F2R
NB763K	e.motion® PS Femur F3R
NB764K	e.motion® PS Femur F4R
NB765K	e.motion® PS Femur F5R
NB766K	e.motion® PS Femur F6R
NB767K	e.motion® PS Femur F7R
NB768K	e.motion® PS Femur F8R



ISODUR[®]

Plasmapore[®] μ -CaP

Modular Tibia Plateau UC / PS

cemented – zementiert

Art No.	Description	
left – links		
Standard-Version		AS-Version
NB731K	e.motion® UC/PS Tibia Plateau T1L	NB731Z
NB732K	e.motion® UC/PS Tibia Plateau T2L	NB732Z
NB733K	e.motion® UC/PS Tibia Plateau T3L	NB733K
NB734K	e.motion® UC/PS Tibia Plateau T4L	NB734Z
NB735K	e.motion® UC/PS Tibia Plateau T5L	NB735Z
NB736K	e.motion® UC/PS Tibia Plateau T6L	NB736Z
NB737K	e.motion® UC/PS Tibia Plateau T7L	NB737Z
NB738K	e.motion® UC/PS Tibia Plateau T8L	NB738Z
right – rechts		
NB781K	e.motion® UC/PS Tibia Plateau T1R	NB781Z
NB782K	e.motion® UC/PS Tibia Plateau T2R	NB782Z
NB783K	e.motion® UC/PS Tibia Plateau T3R	NB783Z
NB784K	e.motion® UC/PS Tibia Plateau T4R	NB784Z
NB785K	e.motion® UC/PS Tibia Plateau T5R	NB785Z
NB786K	e.motion® UC/PS Tibia Plateau T6R	NB786Z
NB787K	e.motion® UC/PS Tibia Plateau T7R	NB787Z
NB788K	e.motion® UC/PS Tibia Plateau T8R	NB788Z



ISODUR[®]

Modular Tibia Plateau UC / PS

cementless – zementfrei

Art No.	Description
left – links	
NB741K	e.motion® UC/PS Tibia Plateau T1L
NB742K	e.motion® UC/PS Tibia Plateau T2L
NB743K	e.motion® UC/PS Tibia Plateau T3L
NB744K	e.motion® UC/PS Tibia Plateau T4L
NB745K	e.motion® UC/PS Tibia Plateau T5L
NB746K	e.motion® UC/PS Tibia Plateau T6L
NB747K	e.motion® UC/PS Tibia Plateau T7L
NB748K	e.motion® UC/PS Tibia Plateau T8L
right – rechts	
NB791K	e.motion® UC/PS Tibia Plateau T1R
NB792K	e.motion® UC/PS Tibia Plateau T2R
NB793K	e.motion® UC/PS Tibia Plateau T3R
NB794K	e.motion® UC/PS Tibia Plateau T4R
NB795K	e.motion® UC/PS Tibia Plateau T5R
NB796K	e.motion® UC/PS Tibia Plateau T6R
NB797K	e.motion® UC/PS Tibia Plateau T7R
NB798K	e.motion® UC/PS Tibia Plateau T8R



ISODUR[®]

Plasmapore[®] μ-CaP

Meniscal Component UC – with rotational axis in Standard-Version

Meniscal Component – Meniskuskomponente

Art No.	Description	
left - links		
10 mm		12 mm
NR802	e.motion® UC Meniscal Component F2L	NR812
NR803	e.motion® UC Meniscal Component F3L	NR813
NR804	e.motion® UC Meniscal Component F4L	NR814
NR805	e.motion® UC Meniscal Component F5L	NR815
NR806	e.motion® UC Meniscal Component F6L	NR816
NR807	e.motion® UC Meniscal Component F7L	NR817
NR808	e.motion® UC Meniscal Component F8L	NR818
14 mm		16 mm
NR822	e.motion® UC Meniscal Component F2L	NR832
NR823	e.motion® UC Meniscal Component F3L	NR833
NR824	e.motion® UC Meniscal Component F4L	NR834
NR825	e.motion® UC Meniscal Component F5L	NR835
NR826	e.motion® UC Meniscal Component F6L	NR836
NR827	e.motion® UC Meniscal Component F7L	NR837
NR828	e.motion® UC Meniscal Component F8L	NR838
18 mm		20 mm
NR842	e.motion® UC Meniscal Component F2L	NR852
NR843	e.motion® UC Meniscal Component F3L	NR853
NR844	e.motion® UC Meniscal Component F4L	NR854
NR845	e.motion® UC Meniscal Component F5L	NR855
NR846	e.motion® UC Meniscal Component F6L	NR856
NR847	e.motion® UC Meniscal Component F7L	NR857
NR848	e.motion® UC Meniscal Component F8L	NR858



UHMWPE



Meniscal Component UC – with rotational axis in Standard-Version

Meniscal Component – Meniskuskomponente

Art No.	Description	
right – rechts		
10 mm		12 mm
NR902	e.motion® UC Meniscal Component F2R	NR912
NR903	e.motion® UC Meniscal Component F3R	NR913
NR904	e.motion® UC Meniscal Component F4R	NR914
NR905	e.motion® UC Meniscal Component F5R	NR915
NR906	e.motion® UC Meniscal Component F6R	NR916
NR907	e.motion® UC Meniscal Component F7R	NR917
NR908	e.motion® UC Meniscal Component F8R	NR918
14 mm		16 mm
NR922	e.motion® UC Meniscal Component F2R	NR932
NR923	e.motion® UC Meniscal Component F3R	NR933
NR924	e.motion® UC Meniscal Component F4R	NR934
NR925	e.motion® UC Meniscal Component F5R	NR935
NR926	e.motion® UC Meniscal Component F6R	NR936
NR927	e.motion® UC Meniscal Component F7R	NR937
NR928	e.motion® UC Meniscal Component F8R	NR938
18 mm		20 mm
NR942	e.motion® UC Meniscal Component F2R	NR952
NR943	e.motion® UC Meniscal Component F3R	NR953
NR944	e.motion® UC Meniscal Component F4R	NR954
NR945	e.motion® UC Meniscal Component F5R	NR955
NR946	e.motion® UC Meniscal Component F6R	NR956
NR947	e.motion® UC Meniscal Component F7R	NR957
NR948	e.motion® UC Meniscal Component F8R	NR958



UHMWPE



Meniscal Component PS – with rotational axis in Standard-Version

Meniscal Component – Meniskuskomponente

Art No.	Description	
left – links		
10 mm		12 mm
NB802	e.motion® PS Meniscal Component F2L	NB812
NB803	e.motion® PS Meniscal Component F3L	NB813
NB804	e.motion® PS Meniscal Component F4L	NB814
NB805	e.motion® PS Meniscal Component F5L	NB815
NB806	e.motion® PS Meniscal Component F6L	NB816
NB807	e.motion® PS Meniscal Component F7L	NB817
NB808	e.motion® PS Meniscal Component F8L	NB818
<hr/>		
14 mm		16 mm
NB822	e.motion® PS Meniscal Component F2L	NB832
NB823	e.motion® PS Meniscal Component F3L	NB833
NB824	e.motion® PS Meniscal Component F4L	NB834
NB825	e.motion® PS Meniscal Component F5L	NB835
NB826	e.motion® PS Meniscal Component F6L	NB836
NB827	e.motion® PS Meniscal Component F7L	NB837
NB828	e.motion® PS Meniscal Component F8L	NB838
<hr/>		
18 mm		20 mm
NB842	e.motion® PS Meniscal Component F2L	NB852
NB843	e.motion® PS Meniscal Component F3L	NB853
NB844	e.motion® PS Meniscal Component F4L	NB854
NB845	e.motion® PS Meniscal Component F5L	NB855
NB846	e.motion® PS Meniscal Component F6L	NB856
NB847	e.motion® PS Meniscal Component F7L	NB857
NB848	e.motion® PS Meniscal Component F8L	NB858
<hr/>		
22 mm		24 mm
NB864	e.motion® PS Meniscal Component F4L	NB874
NB865	e.motion® PS Meniscal Component F5L	NB875
NB866	e.motion® PS Meniscal Component F6L	NB876
NB867	e.motion® PS Meniscal Component F7L	NB877
NB868	e.motion® PS Meniscal Component F8L	NB878



Meniscal Component PS – with rotational axis in Standard-Version

Meniscal Component – Meniskuskomponente

Art No.	Description	
right - rechts		
10 mm		12 mm
NB902	e.motion® PS Meniscal Component F2R	NB912
NB903	e.motion® PS Meniscal Component F3R	NB913
NB904	e.motion® PS Meniscal Component F4R	NB914
NB905	e.motion® PS Meniscal Component F5R	NB915
NB906	e.motion® PS Meniscal Component F6R	NB916
NB907	e.motion® PS Meniscal Component F7R	NB917
NB908	e.motion® PS Meniscal Component F8R	NB918
14 mm		16 mm
NB922	e.motion® PS Meniscal Component F2R	NB932
NB923	e.motion® PS Meniscal Component F3R	NB933
NB924	e.motion® PS Meniscal Component F4R	NB934
NB925	e.motion® PS Meniscal Component F5R	NB935
NB926	e.motion® PS Meniscal Component F6R	NB936
NB927	e.motion® PS Meniscal Component F7R	NB937
NB928	e.motion® PS Meniscal Component F8R	NB938
18 mm		20 mm
NB942	e.motion® PS Meniscal Component F2R	NB952
NB943	e.motion® PS Meniscal Component F3R	NB953
NB944	e.motion® PS Meniscal Component F4R	NB954
NB945	e.motion® PS Meniscal Component F5R	NB955
NB946	e.motion® PS Meniscal Component F6R	NB956
NB947	e.motion® PS Meniscal Component F7R	NB957
NB948	e.motion® PS Meniscal Component F8R	NB958
22 mm		24 mm
NB964	e.motion® PS Meniscal Component F4R	NB974
NB965	e.motion® PS Meniscal Component F5R	NB975
NB966	e.motion® PS Meniscal Component F6R	NB976
NB967	e.motion® PS Meniscal Component F7R	NB977
NB968	e.motion® PS Meniscal Component F8R	NB978



Tibia Obturator FP/UC/PS/Revision

Tibia Obturator – Verschlusschraube

Art No.	Description	AS-Version
Standard-Version		AS-Version
NB105K	e.motion® Obturator Ø 12 mm T1/T2/T3	NB105Z
NB106K	e.motion® Obturator Ø 14 mm T4/T5/T6	NB106Z
NB107K	e.motion® Obturator Ø 16 mm T7/T8	NB107Z



ISODUR_F

Tibia Obturator UC Pro/PS Pro

Tibia Obturator – Verschlusschraube

Art No.	Description	AS-Version
Standard-Version		AS-Version
NN264K	Obturator Ø 14 mm T4-T5	NN264Z



ISODUR_F

PEEK Plug

PEEK Plug – PEEK Verschluss

Art No.	Description
NN260P	PEEK Plug T1-T5



PEEK-OPTIMA®

Tibia Extension Stems FP/UC/PS/Revision cementless

Tibia Extension Stem cementless – Verlängerungsschaft zementfrei

Art No.	Description	AS-Version
Standard-Version		AS-Version
NB114K	e.motion® Tibia Stem, short, Ø 10 mm	NB114Z
NB115K	e.motion® Tibia Stem, short, Ø 12 mm	NB115Z
NB116K	e.motion® Tibia Stem, short, Ø 14 mm	NB116Z
NB117K	e.motion® Tibia Stem, short, Ø 16 mm	NB117Z
NB094K	e.motion® Tibia Stem, middle, Ø 10 mm	NB094Z
NB095K	e.motion® Tibia Stem, middle, Ø 12 mm	NB095Z
NB096K	e.motion® Tibia Stem, middle, Ø 14 mm	NB096Z
NB097K	e.motion® Tibia Stem, middle, Ø 16 mm	NB097Z
NB124K	e.motion® Tibia Stem, long, Ø 10 mm	NB124Z
NB125K	e.motion® Tibia Stem, long, Ø 12 mm	NB125Z
NB126K	e.motion® Tibia Stem, long, Ø 14 mm	NB126Z
NB127K	e.motion® Tibia Stem, long, Ø 16 mm	NB127Z



ISODUR_F

Tibia Extension Stems FP/UC/PS/Revision cemented

Tibia Extension Stem cemented – Verlängerungsschaft zementiert

Art No.	Description	AS-Version
Standard-Version		AS-Version
NB213K	e.motion® Tibia Stem, short, Ø 12 mm	NB213Z
NB214K	e.motion® Tibia Stem, short, Ø 14 mm	NB214Z
NB215K	e.motion® Tibia Stem, short, Ø 16 mm	NB215Z
NB218K	e.motion® Tibia Stem, middle, Ø 12 mm	NB218Z
NB219K	e.motion® Tibia Stem, middle, Ø 14 mm	NB219Z
NB220K	e.motion® Tibia Stem, middle, Ø 16 mm	NB220Z
NB223K	e.motion® Tibia Stem, long, Ø 12 mm	NB223Z
NB224K	e.motion® Tibia Stem, long, Ø 14 mm	NB224Z
NB225K	e.motion® Tibia Stem, long, Ø 16 mm	NB225Z



ISODUR_F

Tibia Extension Stems UC Pro/PS Pro cemented

Tibia Extension Stem cemented – Verlängerungsschaft zementiert

Art No.	Description	AS-Version
Standard-Version		AS-Version
NX060K	Tibia Stem, L 52 mm, Ø 10 mm	NX060Z
NX062K	Tibia Stem, L 52 mm, Ø 12 mm	NX062Z
NX063K	Tibia Stem, L 52 mm, Ø 14 mm	NX063Z
NX061K	Tibia Stem, L 92 mm, Ø 10 mm	NX061Z
NX064K	Tibia Stem, L 92 mm, Ø 12 mm	NX064Z
NX065K	Tibia Stem, L 92 mm, Ø 14 mm	NX065Z



ISODUR_F

Tibia Extension Stems UC Pro/PS Pro cemented

Tibia Extension Stem cemented – Verlängerungsschaft zementiert

Art No.	Description	AS-Version
Standard-Version		AS-Version
NB100K	Tibia Stem, L 12 mm, Ø 14 mm	NB100Z
NX082K	Tibia Stem, L 92 mm, Ø 10 mm	NX082Z
NX084K	Tibia Stem, L 92 mm, Ø 12 mm	NX084Z
NX085K	Tibia Stem, L 92 mm, Ø 14 mm	NX085Z
NX083K	Tibia Stem, L 132 mm, Ø 10 mm	NX083Z
NX086K	Tibia Stem, L 132 mm, Ø 12 mm	NX086Z
NX087K	Tibia Stem, L 132 mm, Ø 14 mm	NX087Z



ISODUR_F

Tibial Augments PS / Revision cemented

Tibial Augment cemented – Tibiaplatte zementiert

Art No.	Description	AS-Version
Standard-Version		AS-Version
NB401K	e.motion® Augment T1L+R, medial, 4 mm	NB401Z
NB402K	e.motion® Augment T2L+R, medial, 4 mm	NB402Z
NB403K	e.motion® Augment T3L+R, medial, 4 mm	NB403Z
NB404K	e.motion® Augment T4L+R, medial, 4 mm	NB404Z
NB405K	e.motion® Augment T5L+R, medial, 4 mm	NB405Z
NB406K	e.motion® Augment T6L+R, medial, 4 mm	NB406Z
NB407K	e.motion® Augment T7L+R, medial, 4 mm	NB407Z
NB408K	e.motion® Augment T8L+R, medial, 4 mm	NB408Z
NB411K	e.motion® Augment T1L+R, lateral, 4 mm	NB411Z
NB412K	e.motion® Augment T2L+R, lateral, 4 mm	NB412Z
NB413K	e.motion® Augment T3L+R, lateral, 4 mm	NB413Z
NB414K	e.motion® Augment T4L+R, lateral, 4 mm	NB414Z
NB415K	e.motion® Augment T5L+R, lateral, 4 mm	NB415Z
NB416K	e.motion® Augment T6L+R, lateral, 4 mm	NB416Z
NB417K	e.motion® Augment T7L+R, lateral, 4 mm	NB417Z
NB418K	e.motion® Augment T8L+R, lateral, 4 mm	NB418Z
NB421K	e.motion® Augment T1L, medial, 8 mm	NB421Z
NB422K	e.motion® Augment T2L, medial, 8 mm	NB422Z
NB423K	e.motion® Augment T3L, medial, 8 mm	NB423Z
NB424K	e.motion® Augment T4L, medial, 8 mm	NB424Z
NB425K	e.motion® Augment T5L, medial, 8 mm	NB425Z
NB426K	e.motion® Augment T6L, medial, 8 mm	NB426Z
NB427K	e.motion® Augment T7L, medial, 8 mm	NB427Z
NB428K	e.motion® Augment T8L, medial, 8 mm	NB428Z
NB431K	e.motion® Augment T1R, medial, 8 mm	NB431Z
NB432K	e.motion® Augment T2R, medial, 8 mm	NB432Z
NB433K	e.motion® Augment T3R, medial, 8 mm	NB433Z
NB434K	e.motion® Augment T4R, medial, 8 mm	NB434Z
NB435K	e.motion® Augment T5R, medial, 8 mm	NB435Z
NB436K	e.motion® Augment T6R, medial, 8 mm	NB436Z
NB437K	e.motion® Augment T7R, medial, 8 mm	NB437Z
NB438K	e.motion® Augment T8R, medial, 8 mm	NB438Z
NB441K	e.motion® Augment T1L, lateral, 8 mm	NB441Z
NB442K	e.motion® Augment T2L, lateral, 8 mm	NB442Z
NB443K	e.motion® Augment T3L, lateral, 8 mm	NB443Z
NB444K	e.motion® Augment T4L, lateral, 8 mm	NB444Z
NB445K	e.motion® Augment T5L, lateral, 8 mm	NB445Z
NB446K	e.motion® Augment T6L, lateral, 8 mm	NB446Z
NB447K	e.motion® Augment T7L, lateral, 8 mm	NB447Z
NB448K	e.motion® Augment T8L, lateral, 8 mm	NB448Z



ISODUR_F

Tibial Augments PS / Revision cemented

Tibial Augment cemented – Tibiaplatte zementiert

Art No.	Description	AS-Version
Standard-Version		AS-Version
NB451K	e.motion® Augment T1R, lateral, 8 mm	NB451Z
NB452K	e.motion® Augment T2R, lateral, 8 mm	NB452Z
NB453K	e.motion® Augment T3R, lateral, 8 mm	NB453Z
NB454K	e.motion® Augment T4R, lateral, 8 mm	NB454Z
NB455K	e.motion® Augment T5R, lateral, 8 mm	NB455Z
NB456K	e.motion® Augment T6R, lateral, 8 mm	NB456Z
NB457K	e.motion® Augment T7R, lateral, 8 mm	NB457Z
NB458K	e.motion® Augment T8R, lateral, 8 mm	NB458Z
NB461K	e.motion® Augment T1L, medial, 12 mm	NB461Z
NB462K	e.motion® Augment T2L, medial, 12 mm	NB462Z
NB463K	e.motion® Augment T3L, medial, 12 mm	NB463Z
NB464K	e.motion® Augment T4L, medial, 12 mm	NB464Z
NB465K	e.motion® Augment T5L, medial, 12 mm	NB465Z
NB466K	e.motion® Augment T6L, medial, 12 mm	NB466Z
NB467K	e.motion® Augment T7L, medial, 12 mm	NB467Z
NB468K	e.motion® Augment T8L, medial, 12 mm	NB468Z
NB471K	e.motion® Augment T1R, medial, 12 mm	NB471Z
NB472K	e.motion® Augment T2R, medial, 12 mm	NB472Z
NB473K	e.motion® Augment T3R, medial, 12 mm	NB473Z
NB474K	e.motion® Augment T4R, medial, 12 mm	NB474Z
NB475K	e.motion® Augment T5R, medial, 12 mm	NB475Z
NB476K	e.motion® Augment T6R, medial, 12 mm	NB476Z
NB477K	e.motion® Augment T7R, medial, 12 mm	NB477Z
NB478K	e.motion® Augment T8R, medial, 12 mm	NB478Z
NB481K	e.motion® Augment T1L, lateral, 12 mm	NB481Z
NB482K	e.motion® Augment T2L, lateral, 12 mm	NB482Z
NB483K	e.motion® Augment T3L, lateral, 12 mm	NB483Z
NB484K	e.motion® Augment T4L, lateral, 12 mm	NB484Z
NB485K	e.motion® Augment T5L, lateral, 12 mm	NB485Z
NB486K	e.motion® Augment T6L, lateral, 12 mm	NB486Z
NB487K	e.motion® Augment T7L, lateral, 12 mm	NB487Z
NB488K	e.motion® Augment T8L, lateral, 12 mm	NB488Z
NB491K	e.motion® Augment T1R, lateral, 12 mm	NB491Z
NB492K	e.motion® Augment T2R, lateral, 12 mm	NB492Z
NB493K	e.motion® Augment T3R, lateral, 12 mm	NB493Z
NB494K	e.motion® Augment T4R, lateral, 12 mm	NB494Z
NB495K	e.motion® Augment T5R, lateral, 12 mm	NB495Z
NB496K	e.motion® Augment T6R, lateral, 12 mm	NB496Z
NB497K	e.motion® Augment T7R, lateral, 12 mm	NB497Z
NB498K	e.motion® Augment T8R, lateral, 12 mm	NB498Z



ISODUR_F

Distal Femoral Augments PS/Revision cemented

Distal Femoral Augment cemented – Distaler Femurkeil zementiert

Art No.	Description	
Standard-Version		AS-Version
NB282K	e.motion® Augment F2 4 mm	NB282Z
NB283K	e.motion® Augment F3 4 mm	NB283Z
NB284K	e.motion® Augment F4 4 mm	NB284Z
NB285K	e.motion® Augment F5 4 mm	NB285Z
NB286K	e.motion® Augment F6 4 mm	NB286Z
NB287K	e.motion® Augment F7 4 mm	NB287Z
NB288K	e.motion® Augment F8 4 mm	NB288Z
NB292K	e.motion® Augment F2 8 mm	NB292Z
NB293K	e.motion® Augment F3 8 mm	NB293Z
NB294K	e.motion® Augment F4 8 mm	NB294Z
NB295K	e.motion® Augment F5 8 mm	NB295Z
NB296K	e.motion® Augment F6 8 mm	NB296Z
NB297K	e.motion® Augment F7 8 mm	NB297Z
NB298K	e.motion® Augment F8 8 mm	NB298Z
NB274K	e.motion® Augment F4 12 mm	
NB275K	e.motion® Augment F5 12 mm	
NB276K	e.motion® Augment F6 12 mm	
NB277K	e.motion® Augment F7 12 mm	
NB278K	e.motion® Augment F8 12 mm	



ISODUR_F

Postero-Distal Femoral Augments PS/Revision cemented

Postero-Distal Femoral Augment cemented – Postero-distaler Femurkeil zementiert

Art No.	Description	AS-Version
Standard-Version		AS-Version
NB302K	e.motion® Augment F2 4 x 4 mm	NB302Z
NB303K	e.motion® Augment F3 4 x 4 mm	NB303Z
NB304K	e.motion® Augment F4 4 x 4 mm	NB304Z
NB305K	e.motion® Augment F5 4 x 4 mm	NB305Z
NB306K	e.motion® Augment F6 4 x 4 mm	NB306Z
NB307K	e.motion® Augment F7 4 x 4 mm	NB307Z
NB308K	e.motion® Augment F8 4 x 4 mm	NB308Z
NB312K	e.motion® Augment F2 4 x 8 mm	NB312Z
NB313K	e.motion® Augment F3 4 x 8 mm	NB313Z
NB314K	e.motion® Augment F4 4 x 8 mm	NB314Z
NB315K	e.motion® Augment F5 4 x 8 mm	NB315Z
NB316K	e.motion® Augment F6 4 x 8 mm	NB316Z
NB317K	e.motion® Augment F7 4 x 8 mm	NB317Z
NB318K	e.motion® Augment F8 4 x 8 mm	NB318Z
NB340K	e.motion® Augment F4 4 x 12 mm	
NB341K	e.motion® Augment F5 4 x 12 mm	
NB342K	e.motion® Augment F6 4 x 12 mm	
NB343K	e.motion® Augment F7 4 x 12 mm	
NB344K	e.motion® Augment F8 4 x 12 mm	
NB322K	e.motion® Augment F2 8 x 4 mm	NB322Z
NB323K	e.motion® Augment F3 8 x 4 mm	NB323Z
NB324K	e.motion® Augment F4 8 x 4 mm	NB324Z
NB325K	e.motion® Augment F5 8 x 4 mm	NB325Z
NB326K	e.motion® Augment F6 8 x 4 mm	NB326Z
NB327K	e.motion® Augment F7 8 x 4 mm	NB327Z
NB328K	e.motion® Augment F8 8 x 4 mm	NB328Z
NB332K	e.motion® Augment F2 8 x 8 mm	NB332Z
NB333K	e.motion® Augment F3 8 x 8 mm	NB333Z
NB334K	e.motion® Augment F4 8 x 8 mm	NB334Z
NB335K	e.motion® Augment F5 8 x 8 mm	NB335Z
NB336K	e.motion® Augment F6 8 x 8 mm	NB336Z
NB337K	e.motion® Augment F7 8 x 8 mm	NB337Z
NB338K	e.motion® Augment F8 8 x 8 mm	NB338Z
NB350K	e.motion® Augment F4 8 x 12 mm	
NB351K	e.motion® Augment F5 8 x 12 mm	
NB352K	e.motion® Augment F6 8 x 12 mm	
NB353K	e.motion® Augment F7 8 x 12 mm	
NB354K	e.motion® Augment F8 8 x 12 mm	



ISODUR_F

Postero-Distal Femoral Augments PS/Revision cemented

Postero-Distal Femoral Augment cemented – Postero-distaler Femurkeil zementiert

Art No.	Description
NB359K	e.motion® Augment F4 12 x 4 mm
NB360K	e.motion® Augment F5 12 x 4 mm
NB361K	e.motion® Augment F6 12 x 4 mm
NB362K	e.motion® Augment F7 12 x 4 mm
NB363K	e.motion® Augment F8 12 x 4 mm
NB364K	e.motion® Augment F4 12 x 8 mm
NB365K	e.motion® Augment F5 12 x 8 mm
NB366K	e.motion® Augment F6 12 x 8 mm
NB367K	e.motion® Augment F7 12 x 8 mm
NB368K	e.motion® Augment F8 12 x 8 mm
NB394K	e.motion® Augment F4 12 x 12 mm
NB395K	e.motion® Augment F5 12 x 12 mm
NB396K	e.motion® Augment F6 12 x 12 mm
NB397K	e.motion® Augment F7 12 x 12 mm
NB398K	e.motion® Augment F8 12 x 12 mm



Femur Extension Stem PS / Revision cementless

Femur Extension Stem cementless – Verlängerungsschaft zementfrei

Art No.	Description	
	Standard-Version	AS-Version
NB236K	e.motion® Stem, short, Ø 14 mm, 5°	NB236Z
NB237K	e.motion® Stem, short, Ø 16 mm, 5°	NB237Z
NB238K	e.motion® Stem, short, Ø 18 mm, 5°	NB238Z
NB239K	e.motion® Stem, short, Ø 20 mm, 5°	NB239Z
NB241K	e.motion® Stem, middle, Ø 14 mm, 5°	NB241Z
NB242K	e.motion® Stem, middle, Ø 16 mm, 5°	NB242Z
NB243K	e.motion® Stem, middle, Ø 18 mm, 5°	NB243Z
NB244K	e.motion® Stem, middle, Ø 20 mm, 5°	NB244Z
NB246K	e.motion® Stem, long, Ø 14 mm, 5°	NB246Z
NB247K	e.motion® Stem, long, Ø 16 mm, 5°	NB247Z
NB248K	e.motion® Stem, long, Ø 18 mm, 5°	NB248Z
NB249K	e.motion® Stem, long, Ø 20 mm, 5°	NB249Z
NB256K	e.motion® Stem, short, Ø 14 mm, 7°	NB256Z
NB257K	e.motion® Stem, short, Ø 16 mm, 7°	NB257Z
NB258K	e.motion® Stem, short, Ø 18 mm, 7°	NB258Z
NB259K	e.motion® Stem, short, Ø 20 mm, 7°	NB259Z
NB261K	e.motion® Stem, middle, Ø 14 mm, 7°	NB261Z
NB262K	e.motion® Stem, middle, Ø 16 mm, 7°	NB262Z
NB263K	e.motion® Stem, middle, Ø 18 mm, 7°	NB263Z
NB264K	e.motion® Stem, middle, Ø 20 mm, 7°	NB264Z
NB266K	e.motion® Stem, long, Ø 14 mm, 7°	NB266Z
NB267K	e.motion® Stem, long, Ø 16 mm, 7°	NB267Z
NB268K	e.motion® Stem, long, Ø 18 mm, 7°	NB268Z
NB269K	e.motion® Stem, long, Ø 20 mm, 7°	NB269Z



ISODUR[®]F

Femur Extension Stem PS / Revision cemented

Femur Extension Stem cemented – Verlängerungsschaft zementiert

Art No.	Description	
	Standard-Version	AS-Version
NB145K	e.motion® Stem, short, Ø 14 mm, 5°	NB145Z
NB144K	e.motion® Stem, short, Ø 16 mm, 5°	NB144Z
NB150K	e.motion® Stem, middle, Ø 14 mm, 5°	NB150Z
NB149K	e.motion® Stem, middle, Ø 16 mm, 5°	NB149Z
NB155K	e.motion® Stem, long, Ø 14 mm, 5°	NB155Z
NB154K	e.motion® Stem, long, Ø 16 mm, 5°	NB154Z
NB135K	e.motion® Stem, short, Ø 14 mm, 7°	NB135Z
NB134K	e.motion® Stem, short, Ø 16 mm, 7°	NB134Z
NB137K	e.motion® Stem, middle, Ø 14 mm, 7°	NB137Z
NB136K	e.motion® Stem, middle, Ø 16 mm, 7°	NB136Z
NB139K	e.motion® Stem, long, Ø 14 mm, 7°	NB139Z
NB138K	e.motion® Stem, long, Ø 16 mm, 7°	NB138Z



ISODUR_F

Nut for Femur Extension Stem PS / Revision

Nut for Femur Extension Stem – Mutter für Verlängerungsschaft

Art No.	Description	
	Standard-Version	AS-Version
NB140K	e.motion® Nut for Femur Extension Stem	NB140Z



ISODUR_F

Patella 3-Peg

Art No.	Description	
NX041	System Patella Size P1	Ø 26 x 7 mm
NX042	System Patella Size P2	Ø 29 x 8 mm
NX043	System Patella Size P3	Ø 32 x 9 mm
NX044	System Patella Size P4	Ø 35 x 10 mm
NX045	System Patella Size P5	Ø 38 x 11 mm







UHMWPE

Saw Blades

Saw Blades – Sägeblätter

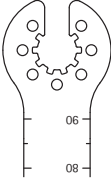
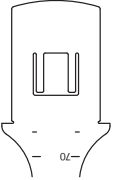
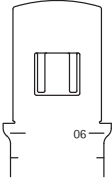
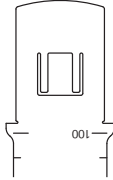
Thickness: 1.27 mm

Connection	Aesculap®	Aesculap® Acculan® 3 Ti	Aesculap® Acculan® 3 Ti	Aesculap® Acculan® 3 Ti	Stryker System 4 + 5 System2000	Conmed / Linvat ec / Hall PowerPro Versipower plus	Synthes
Width	Length 90 mm	Length 75 mm	Length 90 mm	Length 100 mm			

9 mm							
		GE231SU					
13 mm	GE266SU		GE236SU		GE222R	GE220R	GE224R
19 mm	GE271SU		GE241SU	GE249SU			
23 mm	GE276SU		GE246SU		GE223R (25 mm)	GE221R (25 mm)	GE225R (25 mm)

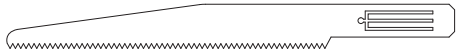
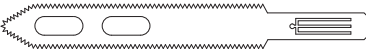
Reciprocating Saw blade 75/10/1.0/1.2 mm	Reciprocating Saw blade 75/12/1.0/1.2 mm
	
GC769R	GC771R

Saw blades: delivered sterile, single use, pack of 1

Implant materials:

ISODUR_C	Cobalt-chrome alloy (CoCrMo/ISO 5832-4)
ISODUR_F	Forged Cobalt-chrome alloy (CoCrMo/ISO 5832-12)
Plasmapore® μ-CaP	Pure-titanium coating with 20 μm Dicalciumphosphate-Dihydrate
UHMWPE	Ultra High Molecular Weight Polyethylene (ISO 5834-2)

Do not use these Instruments to implant any other product:
For implantation of e.motion® prosthesis only

Diese Instrumente sind nicht geeignet zur Implantation
fremder Produkte: Sie sind ausschließlich zur Implantation
von e.motion® Prothesen geeignet

NS701

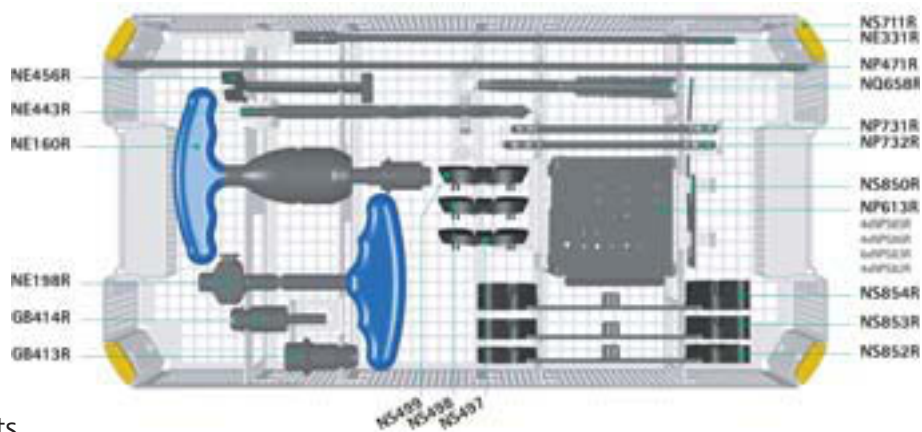

General Instruments

Qty.	Item No.	Description	Qty.	Item No.	Description
1	NS711R	Tray general instruments	1	NE331R	Target rod with sleeve
1	NS497	Complementary spacer 7.0 mm	1	NE456R	Check plate for guiding slots
1	NS498	Complementary spacer 8.5 mm	1	NE443R	Intramedullary drill, Ø 9 x 200 mm
1	NS499	Complementary spacer 10.0 mm	1	NE198R	T-handle
4	NP582R	Fixation screw pins	1	NS852R	Spacer tibial cut only 10-12
6	NP583R	Fixation screw pins	1	NS853R	Spacer tibial cut only 14-16
4	NP585R	Fixation screw pins 30 mm	1	NS854R	Spacer tibial cut only 18-20
4	NP586R	Fixation screw pins	1	NE160R	Torque wrench 10 Nm with T-handle
1	NP613R	Pin driver	1	NQ658R	Torque wrench adapter SW3.5
1	GB413R	Acculan® II hexagonal chuck	1	NP731R	Stem tightening key Ø 10 mm and Ø 12 mm
1	GB414R	Chuck adapter	1	NP732R	Stem tightening key Ø 14 mm and Ø 16 mm
1	NS850R	Cutting depth check blade	1	TF061	Graphic template
1	NP471R	Target rod			

NS702

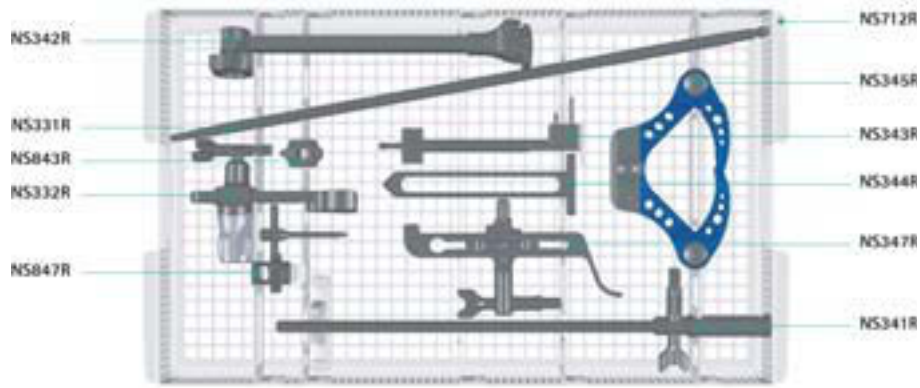

Tibia Preparation

Qty.	Item No.	Description	Qty.	Item No.	Description
1	NS712R	Tray tibia instruments	1	NS347R	Tibia stylus
1	NS669R	Tray tibia instruments base	1	NS843R	Tibia IM orientation sleeve 0°
1	NS341R	Holding rod for tibial cutting guide	1	NS847R	Tibia IM stylus for orientation sleeve
1	NS342R	Tibia alignment system handle	1	NS331R	IM alignment rod Ø 8 mm
1	NS343R	Tibia alignment proximal fixation	1	NS332R	Cutting depth adjustment device
1	NS344R	Tibia alignment bimalleolar clamp support	1	TF062	Graphic template
1	NS345R	Tibia alignment bimalleolar clamp	1	JA455R	Lid for Orthotray

The bottom tray of this set is empty and can be used for optional instrument e.g. distractor NP609R + NP604R. The instrument NE184RM Torque Wrench 20 nm for tightening of stems can be stored here as well. This instrument is only necessary if the set NS858 tibia extension stems is used.

NS703

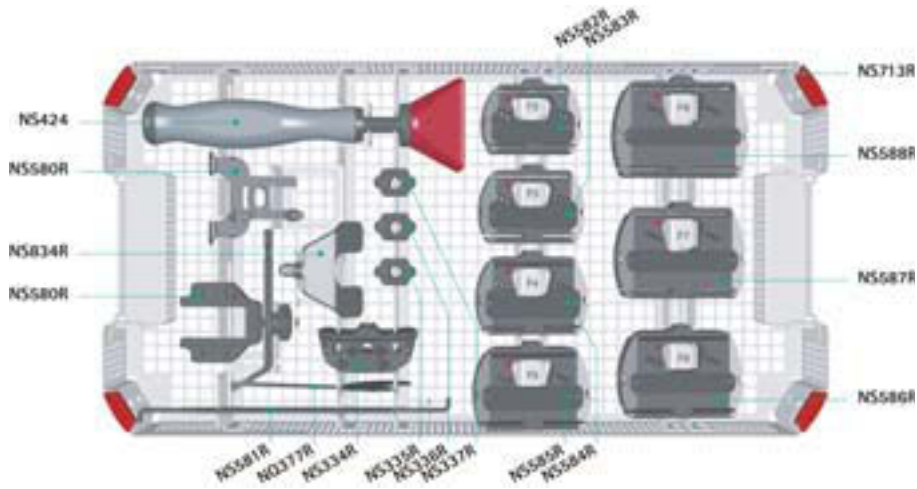

Femur Preparation

Qty.	Item No.	Description	Qty.	Item No.	Description
1	NS713R	Tray femur preparation	1	NS581R	ML femoral size gauge
1	NS580R	Sizing/alignment instrument	1	NQ377R	Protection plate
1	NS582R	4-in-1 femur cutting guide F2	1	NS424	Impactor
1	NS583R	4-in-1 femur cutting guide F3	1	NS334R	Tibio-distal cutting guide
1	NS584R	4-in-1 femur cutting guide F4	1	NS834R	Distal femur contact plate
1	NS585R	4-in-1 femur cutting guide F5	1	NS335R	Angle insert 5° for adjustment device
1	NS586R	4-in-1 femur cutting guide F6	1	NS336R	Angle insert 6° for adjustment device
1	NS587R	4-in-1 femur cutting guide F7	1	NS337R	Angle insert 7° for adjustment device
1	NS588R	4-in-1 femur cutting guide F8	1	TF063	Graphic template
1	JA455R	Lid for Orthotray			

NS704

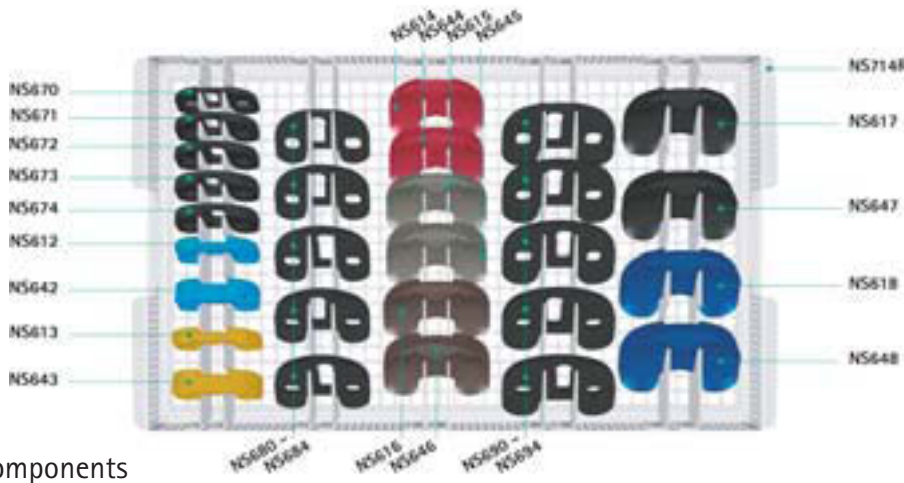

FP Trial Meniscal Components

Qty.	Item No.	Description	Qty.	Item No.	Description
1	NS714R	Tray FP trial meniscal components	1	NS670	FP complement plate sz 1 (S) - 4 mm
1	NS678R	Tray for NS714R	1	NS672	FP complement plate sz 1 (S) R - 6 mm
1	NS612	FP trial meniscal comp. F2 - 6 mm	1	NS671	FP complement plate sz 1 (S) L - 6 mm
1	NS642	FP trial meniscal comp. F2 - 12 mm	1	NS674	FP complement plate sz 1 (S) R - 8 mm
1	NS613	FP trial meniscal comp. F3 - 6 mm	1	NS673	FP complement plate sz 1 (S) L - 8 mm
1	NS643	FP trial meniscal comp. F3 - 12 mm	1	NS680	FP complement plate sz 2 (M) - 4 mm
1	NS614	FP trial meniscal comp. F4 - 6 mm	1	NS682	FP complement plate sz 2 (M) R - 6 mm
1	NS644	FP trial meniscal comp. F4 - 12 mm	1	NS681	FP complement plate sz 2 (M) L - 6 mm
1	NS615	FP trial meniscal comp. F5 - 6 mm	1	NS684	FP complement plate sz 2 (M) R - 8 mm
1	NS645	FP trial meniscal comp. F5 - 12 mm	1	NS683	FP complement plate sz 2 (M) L - 8 mm
1	NS616	FP trial meniscal comp. F6 - 6 mm	1	NS690	FP complement plate sz 3 (L) - 4 mm
1	NS646	FP trial meniscal comp. F6 - 12 mm	1	NS692	FP complement plate sz 3 (L) R - 6 mm
1	NS617	FP trial meniscal comp. F7 - 6 mm	1	NS691	FP complement plate sz 3 (L) L - 6 mm
1	NS647	FP trial meniscal comp. F7 - 12 mm	1	NS694	FP complement plate sz 3 (L) R - 8 mm
1	NS618	FP trial meniscal comp. F8 - 6 mm	1	NS693	FP complement plate sz 3 (L) L - 8 mm
1	NS648	FP trial meniscal comp. F8 - 12 mm			
1	TF064	Graphic template			
1	JA455R	Lid for Orthotray			

NS705

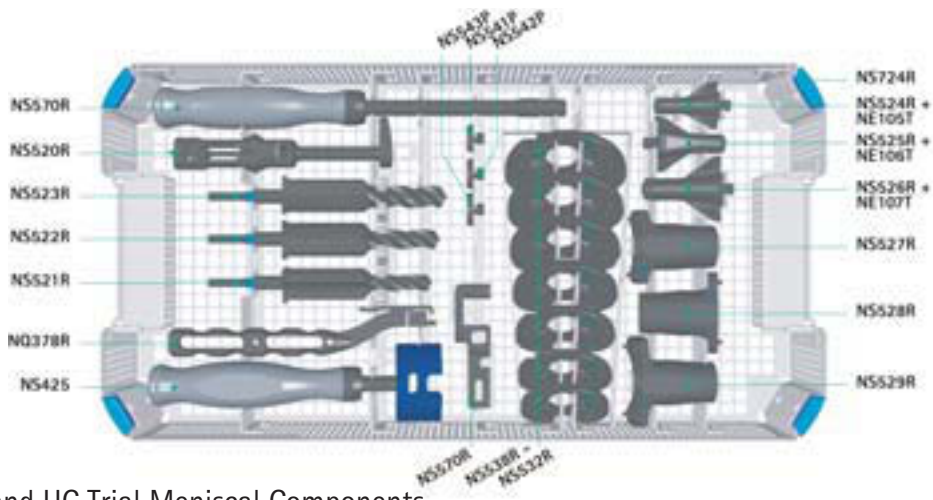

Tibia Preparation and UC Trial Meniscal Components

Qty.	Item No.	Description
1	NS724R	Tray tibia preparation
1	NS520R	Impactor/extractor handle
1	NS521R	Primary drill D 12 mm
1	NS522R	Primary drill D 14 mm
1	NS523R	Primary drill D 16 mm
1	NS524R	Tibial broach T1/T2/T3
1	NS525R	Tibial broach T4/T5/T6
1	NS526R	Tibial broach T7/T8
1	NS527R	Center. sleeve for tibial broach T1/T2/T3
1	NS528R	Center. sleeve for tibial broach T4/T5/T6
1	NS529R	Center. sleeve for tibial broach T7/T8
1	TF065	Graphic template
1	JA455R	Lid for Orthotray

Qty.	Item No.	Description
1	NS532R	Tibia preparation plateau T2
1	NS533R	Tibia preparation plateau T3
1	NS534R	Tibia preparation plateau T4
1	NS535R	Tibia preparation plateau T5
1	NS536R	Tibia preparation plateau T6
1	NS537R	Tibia preparation plateau T7
1	NS538R	Tibia preparation plateau T8
1	NS541P	Rotating peg for preparation plateau T1/T2/T3
1	NS542P	Rotating peg for preparation plateau T4/T5/T6
1	NS543P	Rotating peg for preparation plateau T7/T8
1	NS570R	Tibia counter torque
1	NS425	Impactor
1	NQ378R	Holder for preparation plateau
1	NE105T	Trial obturator 12 mm
1	NE106T	Trial obturator 14 mm
1	NE107T	Trial obturator 16 mm

Insert for NS705



UC Trial Meniscal Components

Qty.	Item No.	Description
1	NS715R	Tray UC trial meniscal components
2	NS622	UC trial meniscal comp. F2 - 6 mm
1	NS652	UC trial meniscal comp. F2 - 12 mm
2	NS623	UC trial meniscal comp. F3 - 6 mm
1	NS653	UC trial meniscal comp. F3 - 12 mm
2	NS624	UC trial meniscal comp. F4 - 6 mm
1	NS654	UC trial meniscal comp. F4 - 12 mm
2	NS625	UC trial meniscal comp. F5 - 6 mm
1	NS655	UC trial meniscal comp. F5 - 12 mm
2	NS626	UC trial meniscal comp. F6 - 6 mm
1	NS656	UC trial meniscal comp. F6 - 12 mm
2	NS627	UC trial meniscal comp. F7 - 6 mm
1	NS657	UC trial meniscal comp. F7 - 12 mm
2	NS628	UC trial meniscal comp. F8 - 6 mm
1	NS658	UC trial meniscal comp. F8 - 12 mm

Qty.	Item No.	Description
1	NS675	PS/UC complement plate sz 1 (S) - 4 mm
1	NS676	PS/UC complement plate sz 1 (S) - 6 mm
1	NS677	PS/UC complement plate sz 1 (S) - 8 mm
1	NS685	PS/UC complement plate sz 2 (M) - 4 mm
1	NS686	PS/UC complement plate sz 2 (M) - 6 mm
1	NS687	PS/UC complement plate sz 2 (M) - 8 mm
1	NS695	PS/UC complement plate sz 3 (L) - 4 mm
1	NS696	PS/UC complement plate sz 3 (L) - 6 mm
1	NS697	PS/UC complement plate sz 3 (L) - 8 mm
1	NS540P	Trial plug UC/PS

NS706

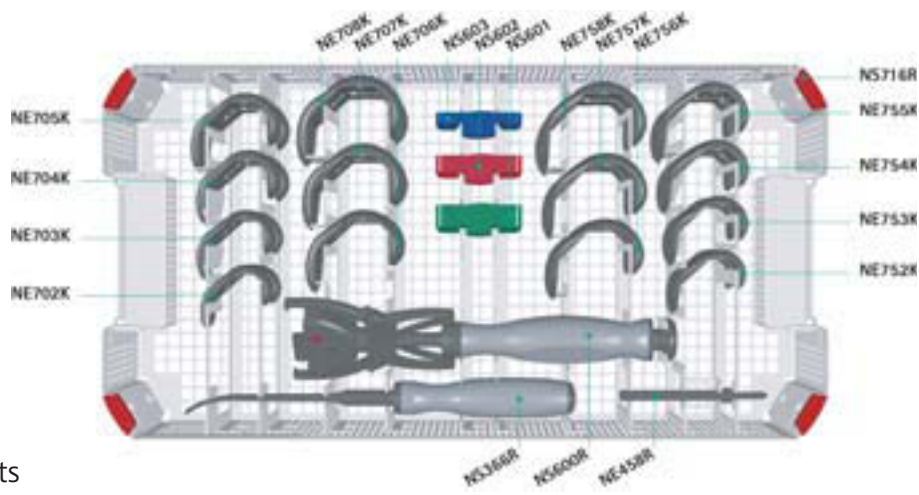

Femur Trial Implants

Qty.	Item No.	Description	Qty.	Item No.	Description
1	NS716R	Tray trial components femur	1	NE705K	Femoral trial implant F5R
1	NS600R	Implant holding/insertion instrument	1	NE755K	Femoral trial implant F5L
1	NS601	Insert for femur F2/F3 for NS600R	1	NE706K	Femoral trial implant F6R
1	NS602	Insert for femur F4/F5/F6 for NS600R	1	NE756K	Femoral trial implant F6L
1	NS603	Insert for femur F7/F8 for NS600R	1	NE707K	Femoral trial implant F7R
1	NE702K	Femoral trial implant F2R	1	NE757K	Femoral trial implant F7L
1	NE752K	Femoral trial implant F2L	1	NE708K	Femoral trial implant F8R
1	NE703K	Femoral trial implant F3R	1	NE758K	Femoral trial implant F8L
1	NE753K	Femoral trial implant F3L	1	NS366R	Chisel for posterior condyles
1	NE704K	Femoral trial implant F4R	1	NE458R	Drill Ø 5 x 25
1	NE754K	Femoral trial implant F4L	1	TF066R	Graphic template
			1	JA455R	Lid for Orthotray

NS707

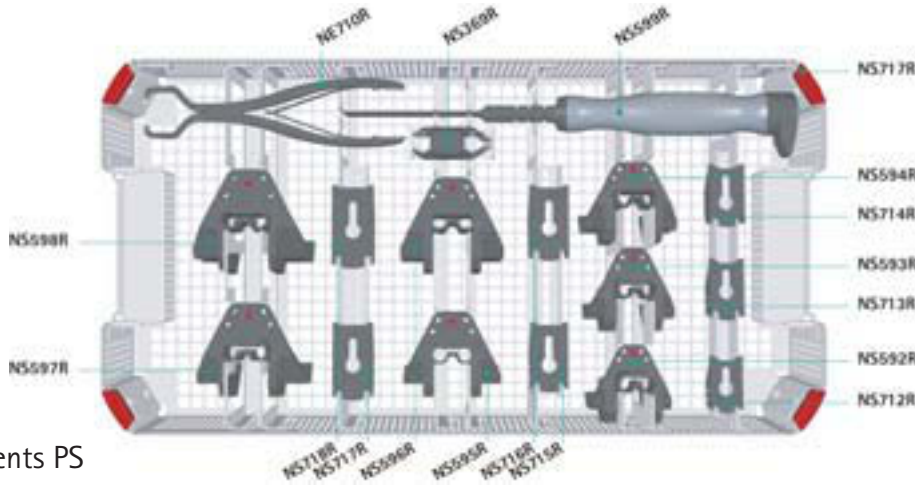

Additional Instruments PS

Qty.	Item No.	Description	Qty.	Item No.	Description
1	NS717R	Tray femur box preparation	1	JA455R	Lid for Orthotray
1	NS592R	Box preparation guide F2	1	NE712R	Click box F2
1	NS593R	Box preparation guide F3	1	NE713R	Click box F3
1	NS594R	Box preparation guide F4	1	NE714R	Click box F4
1	NS595R	Box preparation guide F5	1	NE715R	Click box F5
1	NS596R	Box preparation guide F6	1	NE716R	Click box F6
1	NS597R	Box preparation guide F7	1	NE717R	Click box F7
1	NS598R	Box preparation guide F8	1	NE718R	Click box F8
1	NS599R	Box preparation chisel	1	NE710R	Click box holder
1	TF067	Graphic template	1	NS369R	Stop for box preparation chisel

NS708

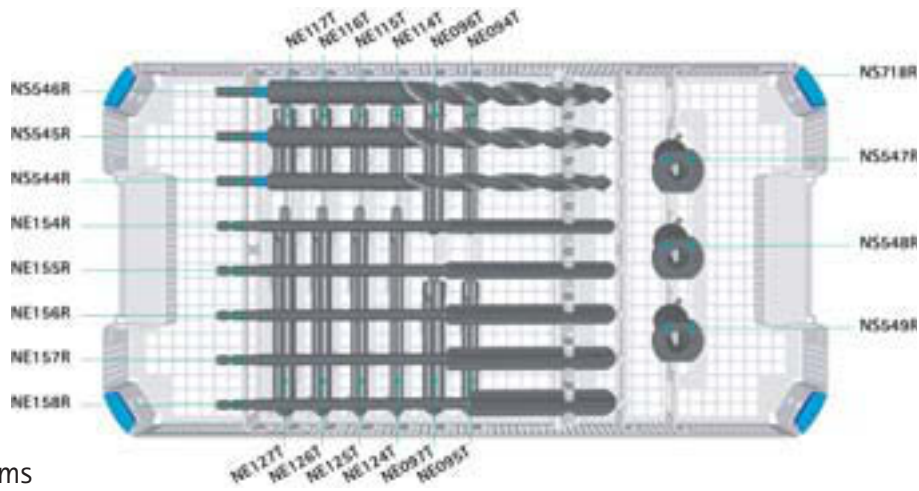

Tibia Extension Stems

Qty.	Item No.	Description
1	NS718R	Tray tibia extension stems
1	NS544R	Drill D 12 mm for extension stem 52/92
1	NS545R	Drill D 14 mm for extension stem 52/92
1	NS546R	Drill D 16 mm for extension stem 52/92
1	NS547R	Tibia drill sleeve D 12 mm
1	NS548R	Tibia drill sleeve D 14 mm
1	NS549R	Tibia drill sleeve D 16 mm
1	NE114T	Trial extension stem Ø 10, 52 mm (S)
1	NE094T	Trial extension stem Ø 10, 92 mm (M)
1	NE124T	Trial extension stem Ø 10, 132 mm (L)
1	NE115T	Trial extension stem Ø 12, 52 mm (S)
1	NE095T	Trial extension stem Ø 12, 92 mm (M)
1	TF068	Graphic template
1	JA455R	Lid for Orthotray

Qty.	Item No.	Description
1	NE125T	Trial extension stem Ø 12, 132 mm (L)
1	NE116T	Trial extension stem Ø 14, 52 mm (S)
1	NE096T	Trial extension stem Ø 14, 92 mm (M)
1	NE126T	Trial extension stem Ø 14, 132 mm (L)
1	NE117T	Trial extension stem Ø 16, 52 mm (S)
1	NE097T	Trial extension stem Ø 16, 92 mm (M)
1	NE127T	Trial extension stem Ø 16, 132 mm (L)
1	NE154R	Reamer Ø 10 mm
1	NE155R	Reamer Ø 12 mm
1	NE156R	Reamer Ø 14 mm
1	NE157R	Reamer Ø 16 mm
1	NE158R	Reamer Ø 18 mm

NS709

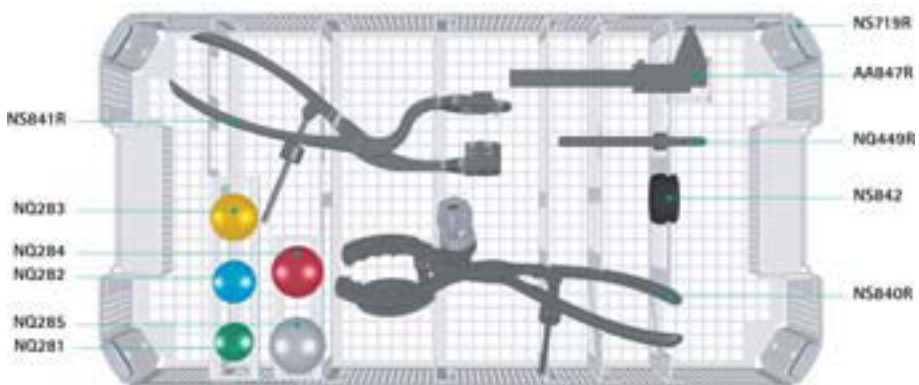

Patella Preparation

Qty.	Item No.	Description
1	NS719R	Tray patella preparation
1	NS840R	Patella resection clamp
1	NS841R	Patella drilling and impacting clamp
1	NS842	Insert for NS841R
1	AA847R	Caliper
1	NQ281	Trial patella 3 pegs P1 Ø 27 x 7 mm

Qty.	Item No.	Description
1	NQ282	Trial patella 3 pegs P2 Ø 30 x 8 mm
1	NQ283	Trial patella 3 pegs P3 Ø 33 x 9 mm
1	NQ284	Trial patella 3 pegs P4 Ø 36 x 10 mm
1	NQ285	Trial patella 3 pegs P5 Ø 39 x 11 mm
1	NQ449R	Drill with stop Ø 6 x 28 mm
1	TF069	Graphic template
1	JA455R	Lid for Orthotray

NS720

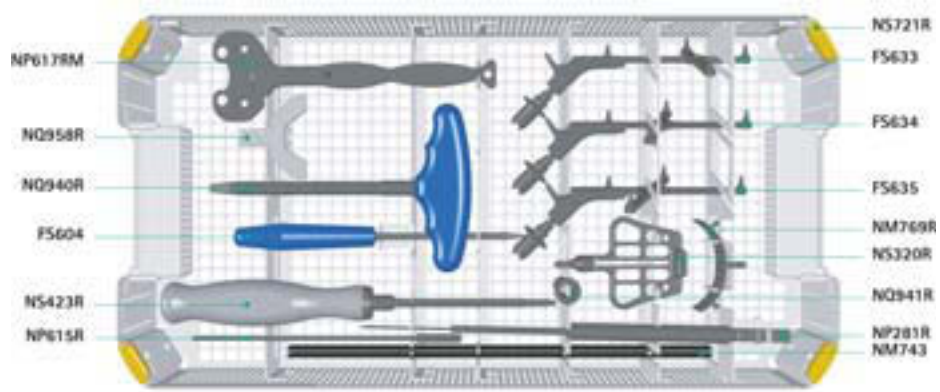

Navigation Instruments

Qty.	Item No.	Description
1	NS721R	Tray navigation instruments
1	NP617RM	Tibial cut control plate
1	FS604	Straight pointer
1	FS633	Passive transmitter yellow
1	FS634	Passive transmitter blue
1	FS635	Passive transmitter red
1	NM769R	Footplate
2	NM743	2x elastic holding strap

Qty.	Item No.	Description
1	NP615R	Drill, Ø 3.2 mm
1	KH398R	Screw length measuring device
1	NQ941R	Soft-tissue protector for transmitter screw
1	NQ940R	Soft-tissue protector handle for transmitter screw
1	NS320R	Navigated femur alignment block
1	NQ958R	Y-footplate for alignment block
1	NS423R	Screw driver SW3.5
1	TF070	Graphic template
1	JA455R	Lid for Orthotray

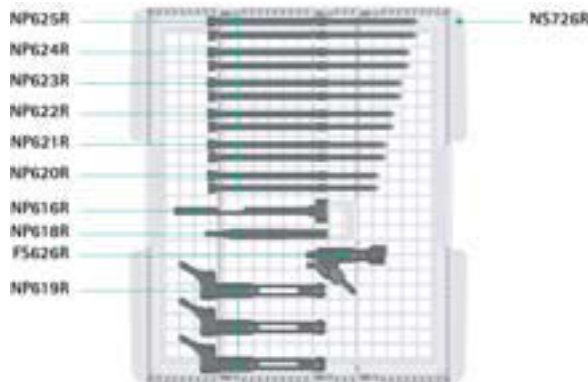

Qty.	Item No.	Description
1	NS726R	Tray insert navigation instruments
3	NP619R	3x screw sleeve with adapter
1	NP618R	Screw driver with hex connection, Ø 3.5 mm
1	NP616R	Insertion aid, Ø 3.2 mm
2	NP620R	2x bicortical screws, 30 mm
2	NP621R	2x bicortical screws, 35 mm
2	NP622R	2x bicortical screws, 40 mm
2	NP623R	2x bicortical screws, 45 mm
2	NP624R	2x bicortical screws, 50 mm
2	NP625R	2x bicortical screws, 55 mm
1	FS626R	Modular Rigid Body adapter

NS730

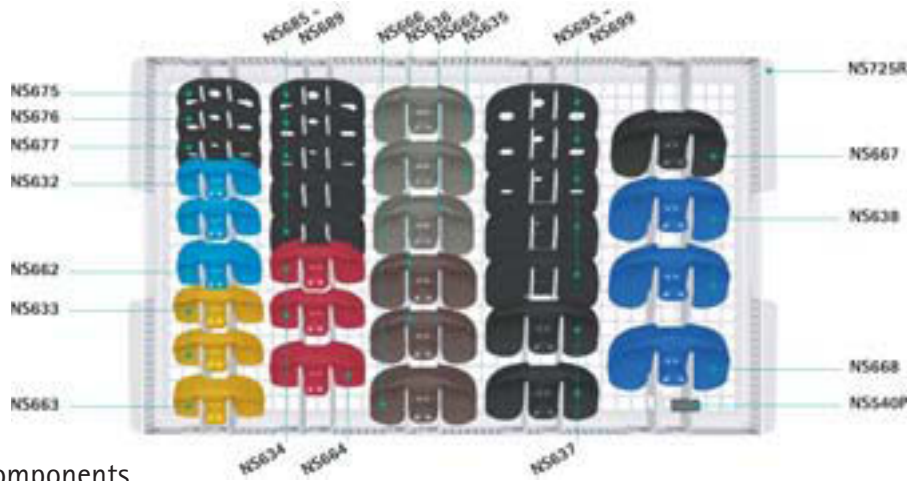

PS Trial Meniscal Components

Qty.	Item No.	Description
1	NS725R	Tray PS trial meniscal components
2	NS632	PS trial meniscal comp. F2 - 6 mm
1	NS662	PS trial meniscal comp. F2 - 12 mm
2	NS633	PS trial meniscal comp. F3 - 6 mm
1	NS663	PS trial meniscal comp. F3 - 12 mm
2	NS634	PS trial meniscal comp. F4 - 6 mm
1	NS664	PS trial meniscal comp. F4 - 12 mm
2	NS635	PS trial meniscal comp. F5 - 6 mm
1	NS665	PS trial meniscal comp. F5 - 12 mm
2	NS636	PS trial meniscal comp. F6 - 6 mm
1	NS666	PS trial meniscal comp. F6 - 12 mm
2	NS637	PS trial meniscal comp. F7 - 6 mm
1	NS667	PS trial meniscal comp. F7 - 12 mm
2	NS638	PS trial meniscal comp. F8 - 6 mm
1	NS668	PS trial meniscal comp. F8 - 12 mm
1	NS678	Tray for NS725R
1	JA455R	Lid for Orthotray

Qty.	Item No.	Description
1	NS675	PS/UC complement plate sz 1 (S) - 4 mm
1	NS676	PS/UC complement plate sz 1 (S) - 6 mm
1	NS677	PS/UC complement plate sz 1 (S) - 8 mm
1	NS685	PS/UC complement plate sz 2 (M) - 4 mm
1	NS686	PS/UC complement plate sz 2 (M) - 6 mm
1	NS687	PS/UC complement plate sz 2 (M) - 8 mm
1	NS688	PS complement plate sz 2 (M) - 10 mm
1	NS689	PS complement plate sz 2 (M) - 12 mm
1	NS695	PS/UC complement plate sz 3 (L) - 4 mm
1	NS696	PS/UC complement plate sz 3 (L) - 6 mm
1	NS697	PS/UC complement plate sz 3 (L) - 8 mm
1	NS698	PS complement plate sz 3 (L) - 10 mm
1	NS699	PS complement plate sz 3 (L) - 12 mm
1	NS540P	Trial plug UC/PS
1	TF071	Graphic template

NS768

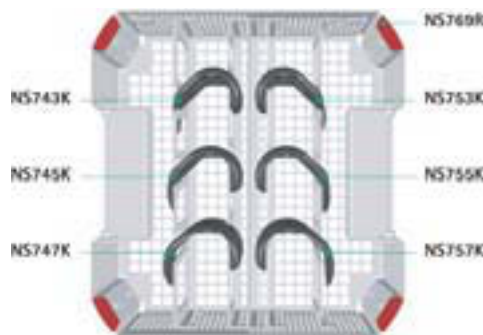

PS Pro Trial Femur Standard Sizes

Qty.	Item No.	Description
1	NS769R	Tray PS Pro standard sizes
1	NS743K	Femoral trial implant F4L
1	NS753K	Femoral trial implant F4R
1	NS745K	Femoral trial implant F5L
1	JA415	Lid for Orthotray

Qty.	Item No.	Description
1	NS755K	Femoral trial implant F5R
1	NS747K	Femoral trial implant F6L
1	NS757K	Femoral trial implant F6R
1	TF075	Graphic template

NS770

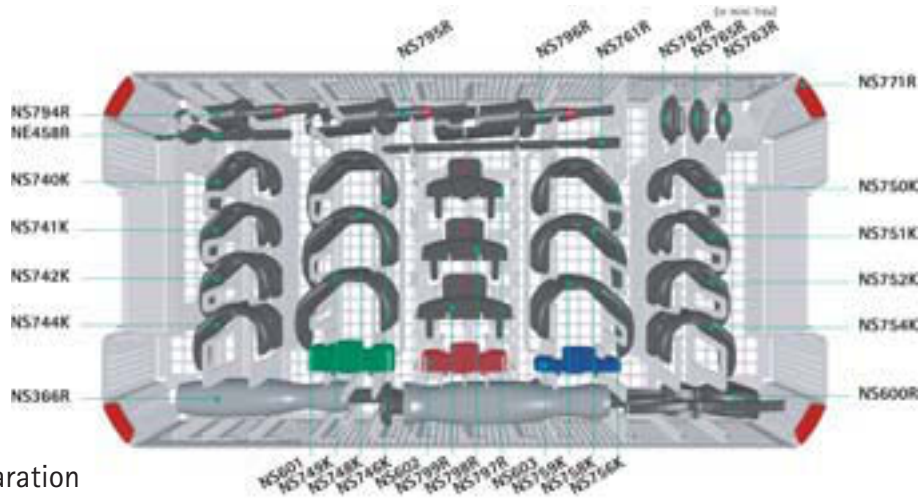

PS Pro Femur Preparation

Qty.	Item No.	Description	Qty.	Item No.	Description
1	NS771R	Tray PS Pro femur preparation	1	NS748K	Femoral trial implant F7L
1	NS600R	IQ implant holding/insertion instrument	1	NS758K	Femoral trial implant F7R
1	NS601	IQ e.motion® insert F/fem. F2/F3 F/NS600R	1	NS749K	Femoral trial implant F8L
1	NS602	IQ e.motion® insert F/fem. F4/F5/F6 F/NS600R	1	NS759K	Femoral trial implant F8R
1	NS603	IQ e.motion® insert F/fem. F7/F8 F/NS600R	1	NS366R	Chisel for posterior condyles
1	NS740K	Femoral trial implant F2L	1	NE458R	Drill Ø 5 x 25
1	NS750K	Femoral trial implant F2R	1	NS794R	e.motion® PS Pro femur box drill S
1	NS741K	Femoral trial implant F3L	1	NS795R	e.motion® PS Pro femur box drill M
1	NS751K	Femoral trial implant F3R	1	NS796R	e.motion® PS Pro femur box drill L
1	NS742K	Femoral trial implant F4NL	1	NS797R	e.motion® PS Pro femur box drill guide S
1	NS752K	Femoral trial implant F4NR	1	NS798R	e.motion® PS Pro femur box drill guide M
1	NS744K	Femoral trial implant F5NL	1	NS799R	e.motion® PS Pro femur box drill guide L
1	NS754K	Femoral trial implant F5NR	1	NS761R	e.motion® PS Pro trial cam insert holder
1	NS746K	Femoral trial implant F6NL	1	TF076	Graphic template
1	NS756K	Femoral trial implant F6NR			
1	JA455R	Lid for Orthotray			

NS780

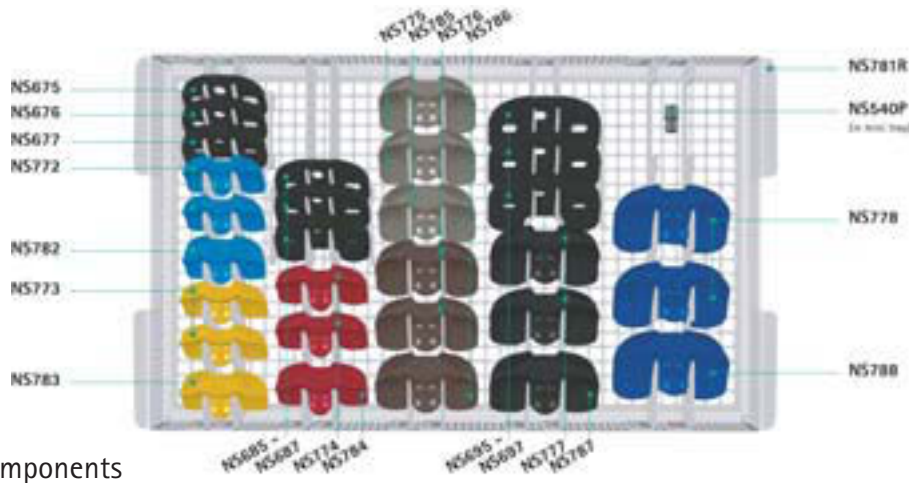

PS Pro Meniscal Components

Qty.	Item No.	Description	Qty.	Item No.	Description
1	NS781R	Tray PS Pro meniscal components	1	NS675	PS/UC complement plate sz 1 (S) - 4 mm
1	NS678R	Tray meniscal components base	1	NS676	PS/UC complement plate sz 1 (S) - 6 mm
1	NS772	PS Pro trial meniscal comp. F2 - 6 mm	1	NS677	PS/UC complement plate sz 1 (S) - 8 mm
1	NS782	PS Pro trial meniscal comp. F2 - 12 mm	1	NS685	PS/UC complement plate sz 2 (M) - 4 mm
1	NS773	PS Pro trial meniscal comp. F3 - 6 mm	1	NS686	PS/UC complement plate sz 2 (M) - 6 mm
1	NS783	PS Pro trial meniscal comp. F3 - 12 mm	1	NS687	PS/UC complement plate sz 2 (M) - 8 mm
1	NS774	PS Pro trial meniscal comp. F4 - 6 mm	1	NS695	PS/UC complement plate sz 3 (L) - 4 mm
1	NS784	PS Pro trial meniscal comp. F4 - 12 mm	1	NS696	PS/UC complement plate sz 3 (L) - 6 mm
1	NS775	PS Pro trial meniscal comp. F5 - 6 mm	1	NS697	PS/UC complement plate sz 3 (L) - 8 mm
1	NS785	PS Pro trial meniscal comp. F5 - 12 mm	1	NS540P	Trial plug UC/PS
1	NS776	PS Pro trial meniscal comp. F6 - 6 mm	1	NS763R	e.motion® PS Pro trial cam insert S
1	NS786	PS Pro trial meniscal comp. F6 - 12 mm	1	NS765R	e.motion® PS Pro trial cam insert M
1	NS777	PS Pro trial meniscal comp. F7 - 6 mm	1	NS767R	e.motion® PS Pro trial cam insert L
1	NS787	PS Pro trial meniscal comp. F7 - 12 mm	1	TF078	Graphic template
1	NS778	PS Pro trial meniscal comp. F8 - 6 mm			
1	NS788	PS Pro trial meniscal comp. F8 - 12 mm			
1	JA455R	Lid for Orthotray			

NS856

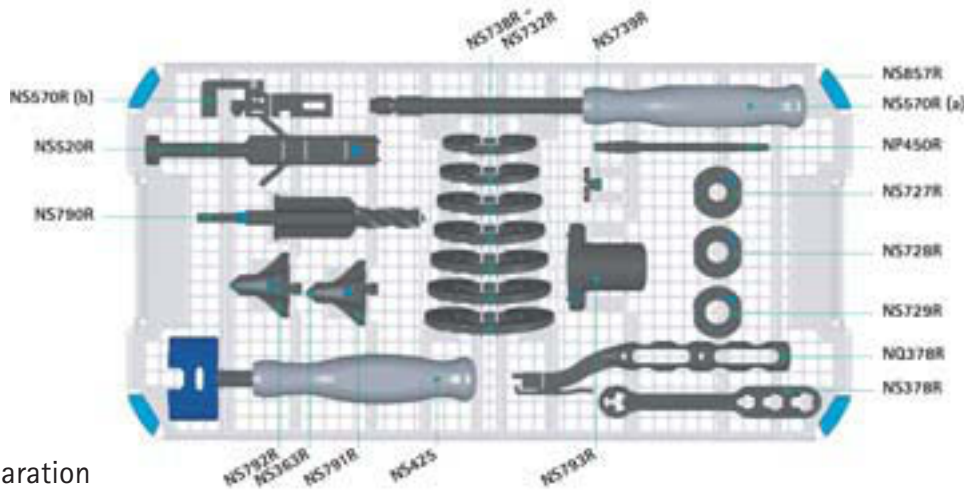

UC Pro Tibia Preparation

Qty.	Item No.	Description
1	NS857R	Tray UC Pro tibia preparation
1	NS520R	IQ e.motion® impactor/extractor handle
1	NS790R	IQ e.motion® primary drill Ø 14 mm
1	NS791R	IQ e.motion® tibia broach L
1	NS792R	IQ e.motion® tibia broach R
1	NS793R	IQ e.motion® center sleeve F/broach
1	NS731R	IQ e.motion® tibia preparation plateau T1
1	NS732R	IQ e.motion® tibia preparation plateau T2
1	NS733R	IQ e.motion® tibia preparation plateau T3
1	NS734R	IQ e.motion® tibia preparation plateau T4
1	NS735R	IQ e.motion® tibia preparation plateau T5
1	NS736R	IQ e.motion® tibia preparation plateau T6
1	NS737R	IQ e.motion® tibia preparation plateau T7
1	NS738R	IQ e.motion® tibia preparation plateau T8

Qty.	Item No.	Description
1	NS739R	IQ e.motion® rot. peg
1	NS570R	IQ e.motion® tibia counter torque
1	NS425	Impactor
1	NQ378R	Holder for preparation plateau
1	NS363R	Probe obturator 12 mm
1	NS378R	Obturator tightening key
1	NS727R	Drill sleeve for extension stem Ø 12 mm
1	NS728R	Drill sleeve for extension stem Ø 14 mm
1	NS729R	Drill sleeve for extension stem Ø 16 mm
1	NP450R	Adapter SW4.5
1	TF078	Graphic template

NS858

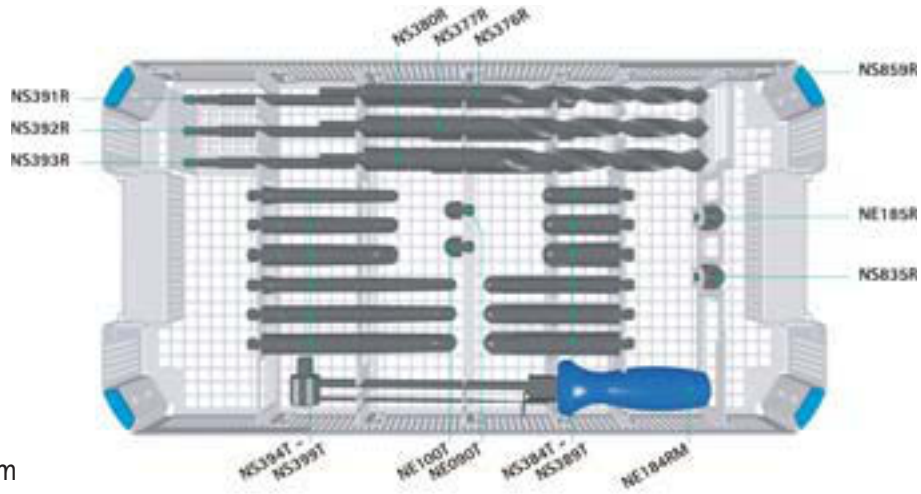

Tibia Extension Stem

Qty.	Item No.	Description	Qty.	Item No.	Description
1	NS859R	Tray tibia extension stem	1	NS399T	Trial stem long Ø 14 mm cementless
1	NS384T	Trial stem short Ø 12 mm cemented	1	NE090T	Trial stem mini Ø 12 mm
1	NS385T	Trial stem short Ø 14 mm cemented	1	NE100T	Trial stem mini Ø 14 mm
1	NS386T	Trial stem short Ø 16 mm cemented	1	NS376R	Drill for cemented stem Ø 12 mm
1	NS387T	Trial stem long Ø 12 mm cemented	1	NS377R	Drill for cemented stem Ø 14 mm
1	NS388T	Trial stem long Ø 14 mm cemented	1	NS380R	Drill for cemented stem Ø 16 mm
1	NS389T	Trial stem long Ø 16 mm cemented	1	NE185R	Stem adapter for NE184RM - 6 mm
1	NS394T	Trial stem short Ø 10 mm cementless	1	NS835R	Stem adapter for NE184RM - 5 mm
1	NS395T	Trial stem short Ø 12 mm cementless	1	NS391R	Reamer for cementless stem Ø 10 mm
1	NS396T	Trial stem short Ø 14 mm cementless	1	NS392R	Reamer for cementless stem Ø 12 mm
1	NS397T	Trial stem long Ø 10 mm cementless	1	NS393R	Reamer for cementless stem Ø 14 mm
1	NS398T	Trial stem long Ø 12 mm cementless	1	NE184RM	Torque Wrench 20 Nm
			1	TF079	Graphic template
			1	JA455R	Lid for Orthotray

NM396

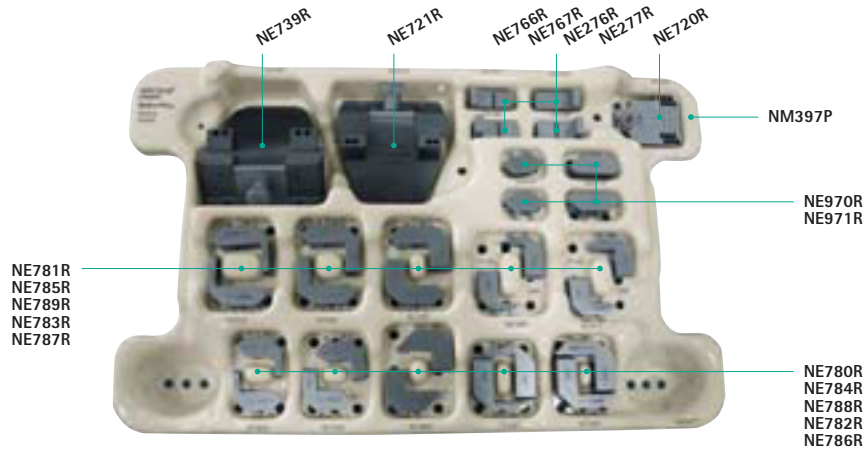

Trial Femur Augments 12 mm

Qty.	Item No.	Description
1	NM397P	Tray
1	NE739R	Add. Instrument post 12 mm res. F7/F8
1	NE721R	Add. Instrument post 12 mm res. F4-F6
1	NE766R	Spacer 12 mm F4-F6 left
1	NE767R	Spacer 12 mm F7/F8 left
1	NE276R	Spacer 12 mm F4-F6 right
1	NE277R	Spacer 12 mm F7/F8 right
1	NE720R	Add. Instrument dist 12 mm res.
2	NE970R	Trial Fem. Augment distal F4-F6 12 mm
2	NE971R	Trial Fem. Augment distal F7/F8 12 mm

Qty.	Item No.	Description
2	NE780R	Trial Fem. Augment post/dist F4-F6 4 x 12 mm
2	NE784R	Trial Fem. Augment post/dist F4-F6 8 x 12 mm
2	NE788R	Trial Fem. Augment post/dist F4-F6 12 x 12 mm
2	NE782R	Trial Fem. Augment post/dist F4-F6 12 x 4 mm
2	NE786R	Trial Fem. Augment post/dist F4-F6 12 x 8 mm
2	NE781R	Trial Fem. Augment post/dist F7/F8 4 x 12 mm
2	NE785R	Trial Fem. Augment post/dist F7/F8 8 x 12 mm
2	NE789R	Trial Fem. Augment post/dist F7/F8 12 x 12 mm
2	NE783R	Trial Fem. Augment post/dist F7/F8 12 x 4 mm
2	NE787R	Trial Fem. Augment post/dist F7/F8 12 x 8 mm

NM398

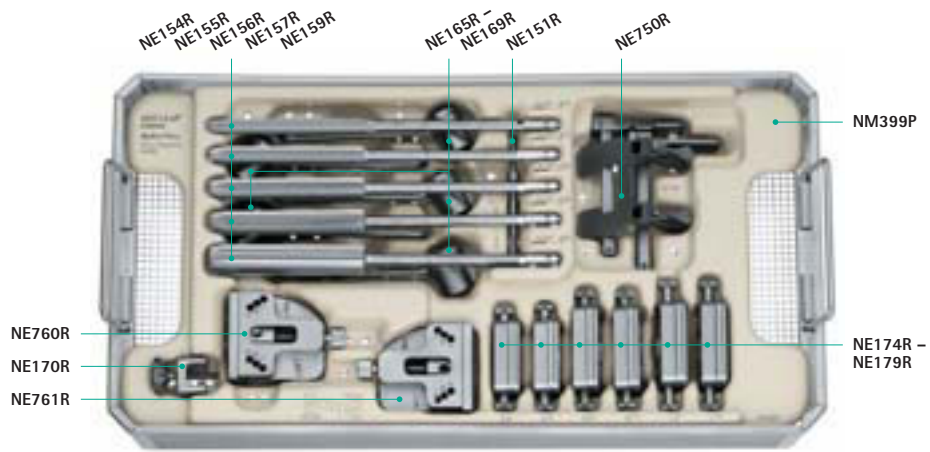

Femur Stem Preparation Instruments

Qty.	Item No.	Description
1	NM399P	Storage
1	NE154R	Reamer for femur extension stem Ø 10 mm
1	NE155R	Reamer for femur extension stem Ø 12 mm
1	NE156R	Reamer for femur extension stem Ø 14 mm
1	NE157R	Reamer for femur extension stem Ø 16 mm
1	NE159R	Reamer for femur extension stem Ø 20 mm
1	NE165R	Reamer guide for femur extension stem Ø 12 mm
1	NE166R	Reamer guide for femur extension stem Ø 14 mm
1	NE167R	Reamer guide for femur extension stem Ø 16 mm
1	NE168R	Reamer guide for femur extension stem Ø 18 mm
1	NE169R	Reamer guide for femur extension stem Ø 20 mm

Qty.	Item No.	Description
1	NE151R	Drill with stop Ø 5 x 35 mm
1	NE750R	Femoro-tibial distractor
1	NE760R	Femur stem alignment block, left
1	NE170R	Clamping piece for femur drill templates
1	NE761R	Femur stem alignment block, right
1	NE174R	Reamer templates for femur ext. stem S 5°
1	NE175R	Reamer templates for femur ext. stem M 5°
1	NE176R	Reamer templates for femur ext. stem L 5°
1	NE177R	Reamer templates for femur ext. stem S 7°
1	NE178R	Reamer templates for femur ext. stem M 7°
1	NE179R	Reamer templates for femur ext. stem L 7°

NM454

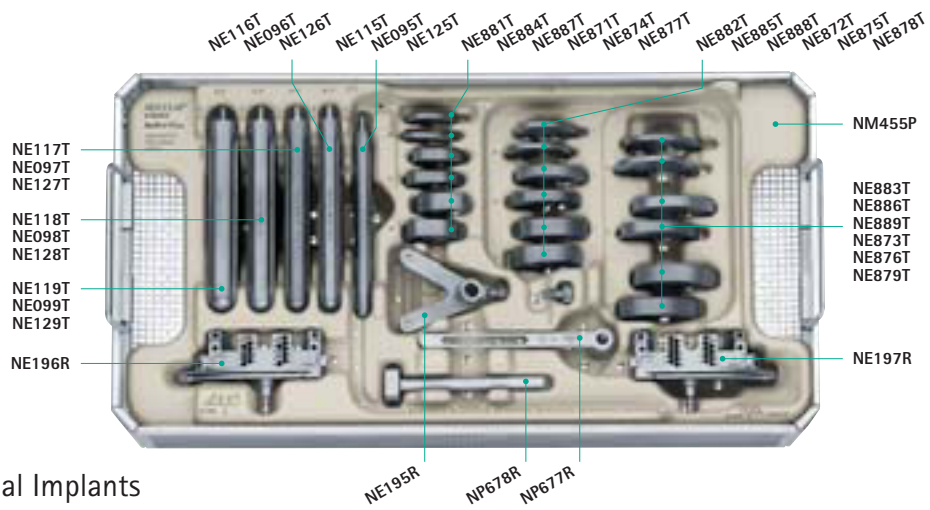

Instruments and Trial Implants

Qty.	Item No.	Description	Qty.	Item No.	Description
1	NM455P	Storage left	1	NE882T	Trial tibial augment T4-6 Lateral 4 mm
1	NE119T	Trial extension stem Ø 20 mm S	1	NE885T	Trial tibial augment T4-6 Lateral 8 mm
1	NE099T	Trial extension stem Ø 20 mm M	1	NE888T	Trial tibial augment T4-6 Lateral 12 mm
1	NE129T	Trial extension stem Ø 20 mm L	1	NE872T	Trial tibial augment T4-6 Medial 4 mm
1	NE118T	Trial extension stem Ø 18 mm S	1	NE875T	Trial tibial augment T4-6 Medial 8 mm
1	NE098T	Trial extension stem Ø 18 mm M	1	NE878T	Trial tibial augment T4-6 Medial 12 mm
1	NE128T	Trial extension stem Ø 18 mm L	1	NE883T	Trial tibial augment T7-8 Lateral 4 mm
1	NE117T	Trial extension stem Ø 16 mm S	1	NE886T	Trial tibial augment T7-8 Lateral 8 mm
1	NE097T	Trial extension stem Ø 16 mm M	1	NE889T	Trial tibial augment T7-8 Lateral 12 mm
1	NE127T	Trial extension stem Ø 16 mm L	1	NE873T	Trial tibial augment T7-8 Medial 4 mm
1	NE116T	Trial extension stem Ø 14 mm S	1	NE876T	Trial tibial augment T7-8 Medial 8 mm
1	NE096T	Trial extension stem Ø 14 mm M	1	NE879T	Trial tibial augment T7-8 Medial 12 mm
1	NE126T	Trial extension stem Ø 14 mm L	1	NE197R	Tibial revision cutting guide, left
1	NE115T	Trial extension stem Ø 12 mm S	1	NP677R	Search evolution® Rev. connector
1	NE095T	Trial extension stem Ø 12 mm M	1	NP678R	Search evolution® Rev. connection block
1	NE125T	Trial extension stem Ø 12 mm L	1	NE195R	Adapter for tibial rev. cutting guide
1	NE881T	Trial tibial augment T1-3 Lateral 4 mm	1	NE196R	Tibial revision cutting guide, right
1	NE884T	Trial tibial augment T1-3 Lateral 8 mm			
1	NE887T	Trial tibial augment T1-3 Lateral 12 mm			
1	NE871T	Trial tibial augment T1-3 Medial 4 mm			
1	NE874T	Trial tibial augment T1-3 Medial 8 mm			
1	NE877T	Trial tibial augment T1-3 Medial 12 mm			

Insert for NM454

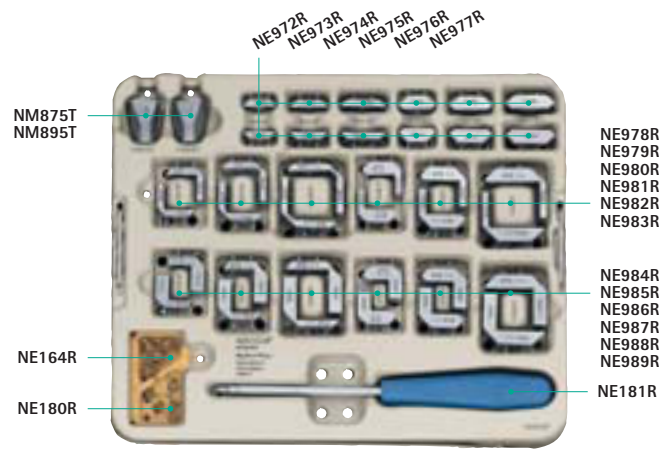

Qty.	Item No.	Description
1	NM875T	Adapter piece for trial femoral stem 5°
1	NM895T	Adapter piece for trial femoral stem 7°
1	NE972R	Trial femoral augment, distal F2/F3, 4 mm
1	NE973R	Trial femoral augment, distal F4-F6, 4 mm
1	NE974R	Trial femoral augment, distal F7/F8, 4 mm
1	NE975R	Trial femoral augment, distal F2/F3, 8 mm
1	NE976R	Trial femoral augment, distal F4-F6, 8 mm
1	NE977R	Trial femoral augment, distal F7/F8, 8 mm
1	NE978R	Trial femoral augment, postero-distal F2/F3, 4 x 4 mm
1	NE979R	Trial femoral augment, postero-distal F4-F6, 4 x 4 mm
1	NE980R	Trial femoral augment, postero-distal F7/F8, 4 x 4 mm
1	NE981R	Trial femoral augment, postero-distal F2/F3, 4 x 8 mm
1	NE982R	Trial femoral augment, postero-distal F4-F6, 4 x 8 mm
1	NE983R	Trial femoral augment, postero-distal F7/F8, 4 x 8 mm

Qty.	Item No.	Description
1	NE984R	Trial femoral augment, postero-distal F2/F3, 8 x 4 mm
1	NE985R	Trial femoral augment, postero-distal F4-F6, 8 x 4 mm
1	NE986R	Trial femoral augment, postero-distal F7/F8, 8 x 4 mm
1	NE987R	Trial femoral augment, postero-distal F2/F3, 8 x 8 mm
1	NE988R	Trial femoral augment, postero-distal F4-F6, 8 x 8 mm
1	NE989R	Trial femoral augment, postero-distal F7/F8, 8 x 8 mm
1	NE181R	Screw driver SW3.0
1	NE180R	Screw for trial wedges
1	NE164R	Screw for trial extension stems

NM458

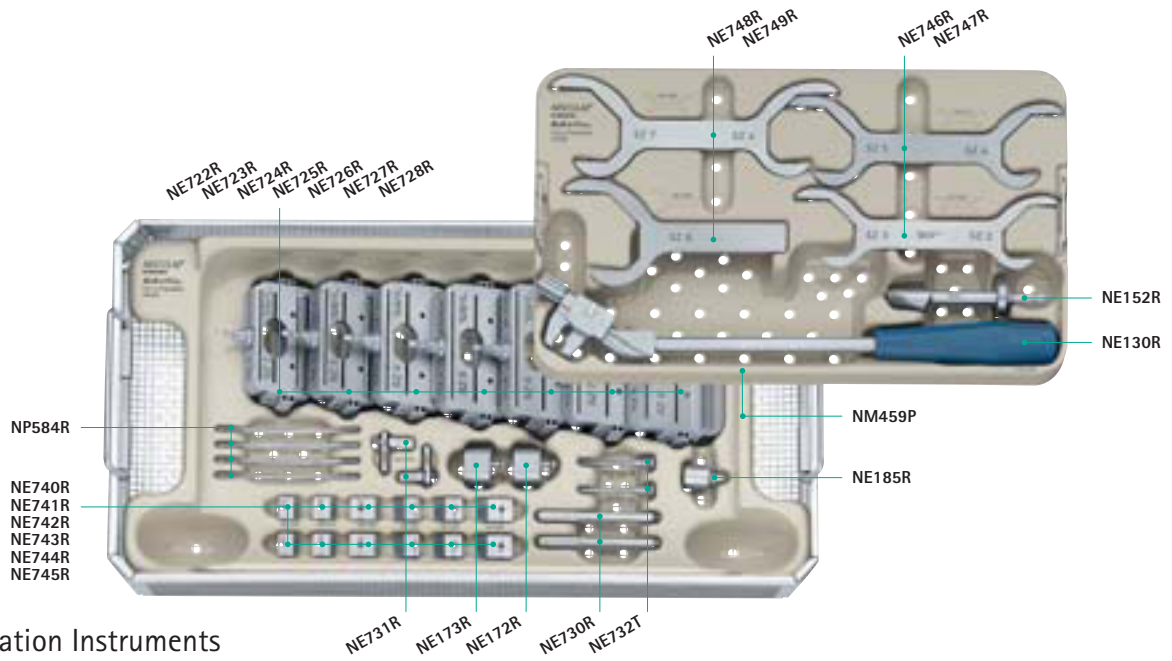

Femur Preparation Instruments

Qty.	Item No.	Description
1	NM459P	Storage left
1	NE722R	Revision cutting guide F2 APC
1	NE723R	Revision cutting guide F3 APC
1	NE724R	Revision cutting guide F4 APC
1	NE725R	Revision cutting guide F5 APC
1	NE726R	Revision cutting guide F6 APC
1	NE727R	Revision cutting guide F7 APC
1	NE728R	Revision cutting guide F8 APC
1	NE746R	Revision femur gauge F2/F3
1	NE747R	Revision femur gauge F4/F5
1	NE748R	Revision femur gauge F6/F7
1	NE749R	Revision femur gauge F8
1	NE152R	Conical rasp for femur stem prep.
1	NE130R	Femur stem holding key
1	NE185R	Torque wrench adapter for femur stem

Qty.	Item No.	Description
1	NE732T	Alignment peg for cutting guide
1	NE730R	Cutting guide handle
1	NE172R	AP orientation sleeve for femur extension stem, neutral
1	NE173R	AP orientation sleeve for femur extension stem, excentric
2	NE731R	Fixation strap for cutting guide
1	NE740R	Spacer F2/F3, 4 mm
1	NE741R	Spacer F4-F6, 4 mm
1	NE742R	Spacer F7/F8, 4 mm
1	NE743R	Spacer F2/F3, 8 mm
1	NE744R	Spacer F4-F6, 8 mm
1	NE745R	Spacer F7/F8, 8 mm
4	NP584R	Pin w/o head 3.2 x 88 mm

NM982

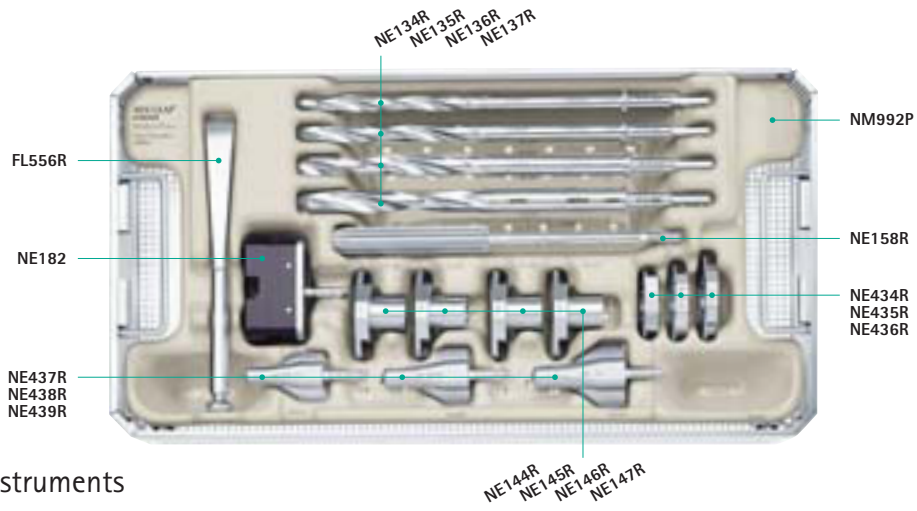

Tibia Preparation Instruments

Qty.	Item No.	Description
1	NM992P	Storage
1	NE134R	Drill Ø 10 mm
1	NE135R	Drill Ø 12 mm
1	NE136R	Drill Ø 14 mm
1	NE137R	Drill Ø 16 mm
1	NE158R	Reamer Ø 18 mm
1	NE434R	Tibial winglet rasp guide T1/T2/T3
1	NE435R	Tibial winglet rasp guide T4/T5/T6
1	NE436R	Tibial winglet rasp guide T7/T8

Qty.	Item No.	Description
1	NE144R	Drilling guide Ø 10 mm
1	NE145R	Drilling guide Ø 12 mm
1	NE146R	Drilling guide Ø 14 mm
1	NE147R	Drilling guide Ø 16 mm
1	NE437R	Winglet rasp tibia T1/T2/T3
1	NE438R	Winglet rasp tibia T4/T5/T6
1	NE439R	Winglet rasp tibia T7/T8
1	NE182	Tibial impactor
1	FL556R	Chisel 20 x 203 mm

NM984

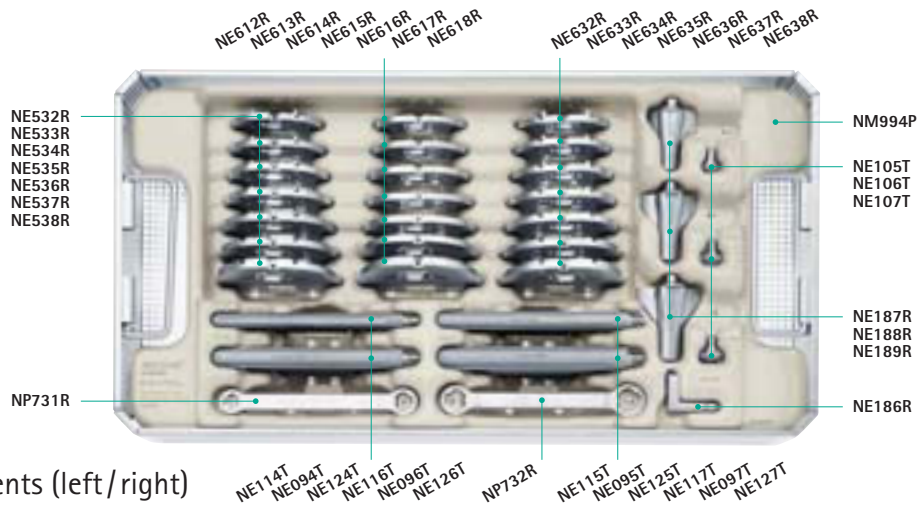

Trial Tibia Components (left/right)

Qty.	Item No.	Description
1	NM994P	Storage
1	NE532R	Tibial preparation plateau, left T2L
1	NE533R	Tibial preparation plateau, left T3L
1	NE534R	Tibial preparation plateau, left T4L
1	NE535R	Tibial preparation plateau, left T5L
1	NE536R	Tibial preparation plateau, left T6L
1	NE537R	Tibial preparation plateau, left T7L
1	NE538R	Tibial preparation plateau, left T8L
1	NE612R	Trial modular tibial plateau T2
1	NE613R	Trial modular tibial plateau T3
1	NE614R	Trial modular tibial plateau T4
1	NE615R	Trial modular tibial plateau T5
1	NE616R	Trial modular tibial plateau T6
1	NE617R	Trial modular tibial plateau T7
1	NE618R	Trial modular tibial plateau T8
1	NE632R	Tibial preparation plateau, right T2R
1	NE633R	Tibial preparation plateau, right T3R
1	NE634R	Tibial preparation plateau, right T4R
1	NE635R	Tibial preparation plateau, right T5R
1	NE636R	Tibial preparation plateau, right T6R
1	NE637R	Tibial preparation plateau, right T7R
1	NE638R	Tibial preparation plateau, right T8R

Qty.	Item No.	Description
1	NE105T	Trial obturator 12 mm
1	NE106T	Trial obturator 14 mm
1	NE107T	Trial obturator 16 mm
1	NE187R	Trial keel T1/T2/T3
1	NE188R	Trial keel T4/T5/T6
1	NE189R	Trial keel T7/T8
1	NE186R	Impaction/extraction adapter
1	NE114T	Trial extension stem Ø 10 mm, S 52 mm
1	NE094T	Trial extension stem Ø 10 mm, M 92 mm
1	NE124T	Trial extension stem Ø 10 mm, L 132 mm
1	NE115T	Trial extension stem Ø 12 mm, S 52 mm
1	NE095T	Trial extension stem Ø 12 mm, M 92 mm
1	NE125T	Trial extension stem Ø 12 mm, L 132 mm
1	NE116T	Trial extension stem Ø 14 mm, S 52 mm
1	NE096T	Trial extension stem Ø 14 mm, M 92 mm
1	NE126T	Trial extension stem Ø 14 mm, L 132 mm
1	NE117T	Trial extension stem Ø 16 mm, S 52 mm
1	NE097T	Trial extension stem Ø 16 mm, M 92 mm
1	NE127T	Trial extension stem Ø 16 mm, L 132 mm
1	NP731R	Stem tightening key Ø 10 mm and Ø 12 mm
1	NP732R	Stem tightening key Ø 14 mm and Ø 16 mm

Femur FP/UC cemented

Types:	F2	F3	F4	F5	F6	F7	F8
Left	N0502K	N0503K	N0504K	N0505K	N0506K	N0507K	N0508K
Right	N0602K	N0603K	N0604K	N0605K	N0606K	N0607K	N0608K



Femur FP/UC cementless

Types:	F2	F3	F4	F5	F6	F7	F8
Left	N0582K	N0583K	N0584K	N0585K	N0586K	N0587K	N0588K
Right	N0682K	N0683K	N0684K	N0685K	N0686K	N0687K	N0688K

Femur PS cemented

Types:	F2	F3	F4	F5	F6	F7	F8
Left	NB702K	NB703K	NB704K	NB705K	NB706K	NB707K	NB708K
Right	NB752K	NB753K	NB754K	NB755K	NB756K	NB757K	NB758K



Femur PS cementless

Types:	F2	F3	F4	F5	F6	F7	F8
Left	NB712K	NB713K	NB714K	NB715K	NB716K	NB717K	NB718K
Right	NB762K	NB763K	NB764K	NB765K	NB766K	NB767K	NB768K

Femur PS Pro cemented

Types:	F2	F3	F4N	F4	F5N	F5	F6N	F6	F7	F8
Left	NX700K	NX701K	NX702K	NX703K	NX704K	NX705K	NX706K	NX707K	NX708K	NX709K
Right	NX750K	NX751K	NX752K	NX753K	NX754K	NX755K	NX756K	NX757K	NX758K	NX759K



Distal Femoral Augments

Types:	F2	F3	F4	F5	F6	F7	F8
4 mm	NB282K	NB283K	NB284K	NB285K	NB286K	NB287K	NB288K
8 mm	NB292K	NB293K	NB294K	NB295K	NB296K	NB297K	NB298K
12 mm			NB274K	NB275K	NB276K	NB277K	NB278K



Patella

Types:	F2-F8
P1	NX041
P2	NX041
P3	NX043
P4	NX044
P5	NX045



Postero-Distal Femoral Augments

Types:	F2	F3	F4	F5	F6	F7	F8
4 x 4 mm	NB302K	NB303K	NB304K	NB305K	NB306K	NB307K	NB308K
4 x 8 mm	NB312K	NB313K	NB314K	NB315K	NB316K	NB317K	NB318K
4 x 12 mm			NB340K	NB341K	NB342K	NB343K	NB344K
8 x 4 mm	NB322K	NB323K	NB324K	NB325K	NB326K	NB327K	NB328K
8 x 8 mm	NB332K	NB333K	NB334K	NB335K	NB336K	NB337K	NB338K
8 x 12 mm			NB350K	NB351K	NB352K	NB353K	NB354K
12 x 4 mm			NB359K	NB360K	NB361K	NB362K	NB363K
12 x 8 mm			NB364K	NB365K	NB366K	NB367K	NB368K
12 x 12 mm			NB394K	NB395K	NB396K	NB397K	NB398K



Tibia FP Monobloc cemented



Types:	T1	T2	T3	T4	T5	T6	T7	T8
Left	NO521K	NO522K	NO523K	NO524K	NO525K	NO526K	NO527K	NO528K
Right	NO621K	NO622K	NO623K	NO624K	NO625K	NO626K	NO627K	NO628K

Tibia FP Modular cemented

Types:	T1	T2	T3	T4	T5	T6	T7	T8
Left	NB521K	NB522K	NB523K	NB524K	NB525K	NB526K	NB527K	NB528K
Right	NB621K	NB622K	NB623K	NB624K	NB625K	NB626K	NB627K	NB628K

Tibia UC/PS Modular cemented



Types:	T1	T2	T3	T4	T5	T6	T7	T8
Left	NB731K	NB732K	NB733K	NB734K	NB735K	NB736K	NB737K	NB738K
Right	NB781K	NB782K	NB783K	NB784K	NB785K	NB786K	NB787K	NB788K

Tibia UC/PS Pro Modular cemented



Types:	T1	T2	T3	T4	T5	T6	T7	T8
Left	NX731K	NX732K	NX733K	NX734K	NX735K	NX736K	NX737K	NX738K
Right	NX781K	NX782K	NX783K	NX784K	NX785K	NX786K	NX787K	NX788K

Tibial Augments



Types:	T1	T2	T3	T4	T5	T6	T7	T8
Left + Right	NB401K	NB402K	NB403K	NB404K	NB405K	NB406K	NB407K	NB408K

4 mm

Types:	T1	T2	T3	T4	T5	T6	T7	T8
Left	NB421K	NB422K	NB423K	NB424K	NB425K	NB426K	NB427K	NB428K
Right	NB431K	NB432K	NB433K	NB434K	NB435K	NB436K	NB437K	NB438K

8 mm

Types:	T1	T2	T3	T4	T5	T6	T7	T8
Left	NB461K	NB462K	NB463K	NB464K	NB465K	NB466K	NB467K	NB468K
Right	NB471K	NB472K	NB473K	NB474K	NB475K	NB476K	NB477K	NB478K

12 mm

Tibia FP Modular cementless

Types:	T1	T2	T3	T4	T5	T6	T7	T8
Left	NB591K	NB592K	NB593K	NB594K	NB595K	NB596K	NB597K	NB598K
Right	NB691K	NB692K	NB693K	NB694K	NB695K	NB696K	NB697K	NB698K

Tibia UC/PS Modular cementless

Types:	T1	T2	T3	T4	T5	T6	T7	T8
Left	NB741K	NB742K	NB743K	NB744K	NB745K	NB746K	NB747K	NB748K
Right	NB791K	NB792K	NB793K	NB794K	NB795K	NB796K	NB797K	NB798K

Tibia-Obturator



Types:	Ø 12	Ø 14	Ø 16	Types:	Ø 14
T1 /T2 /T3	NB105K	--	--	Standard	NN264K
T4 /T5 /T6	--	NB106K	--		
T7 /T8	--	--	NB107K		

Tibia-Obturator for PS Pro



Tibial Augments



Types:	T1	T2	T3	T4	T5	T6	T7	T8
Left + Right	NB411K	NB412K	NB413K	NB414K	NB415K	NB416K	NB417K	NB418K

4 mm

Types:	T1	T2	T3	T4	T5	T6	T7	T8
Left	NB441K	NB442K	NB443K	NB444K	NB445K	NB446K	NB447K	NB448K
Right	NB451K	NB452K	NB453K	NB454K	NB455K	NB456K	NB457K	NB458K

8 mm

Types:	T1	T2	T3	T4	T5	T6	T7	T8
Left	NB461K	NB462K	NB463K	NB464K	NB465K	NB466K	NB467K	NB468K
Right	NB471K	NB472K	NB473K	NB474K	NB475K	NB476K	NB477K	NB478K

12 mm

Femur FP cemented

Types:	F2	F3	F4	F5	F6	F7	F8
Left	N0502Z	N0503Z	N0504Z	N0505Z	N0506Z	N0507Z	N0508Z
Right	N0602Z	N0603Z	N0604Z	N0605Z	N0606Z	N0607Z	N0608Z



Femur PS cemented

Types:	F2	F3	F4	F5	F6	F7	F8
Left	NB702Z	NB703Z	NB704Z	NB705Z	NB706Z	NB707Z	NB708Z
Right	NB752Z	NB753Z	NB754Z	NB755Z	NB756Z	NB757Z	NB758Z



AS Femur PS Pro cemented

Types:	F2	F3	F4N	F4	F5N	F5	F6	F7	F8
Left	NX700Z	NX701Z	NX702Z	NX703Z	NX704Z	NX705Z	NX706Z	NX707Z	NX708Z
Right	NX750Z	NX751Z	NX752Z	NX753Z	NX754Z	NX755Z	NX756Z	NX757Z	NX758Z



Distal Femur Wedges

Types:	F2	F3	F4	F5	F6	F7	F8
4 mm	NB282Z	NB283Z	NB284Z	NB285Z	NB286Z	NB287Z	NB288Z
8 mm	NB292Z	NB293Z	NB294Z	NB295Z	NB296Z	NB297Z	NB298Z



12 mm

Patella
3-Peg

Types:	F2-F8
P1	NX041
P2	NX041
P3	NX043
P4	NX044
P5	NX045



Postero-Distal Femur Wedges

Types:	F2	F3	F4	F5	F6	F7	F8
4 x 4 mm	NB302Z	NB303Z	NB304Z	NB305Z	NB306Z	NB307Z	NB308Z
4 x 8 mm	NB312Z	NB313Z	NB314Z	NB315Z	NB316Z	NB317Z	NB318Z
4 x 12 mm							
8 x 4 mm	NB322Z	NB323Z	NB324Z	NB325Z	NB326Z	NB327Z	NB328Z
8 x 8 mm	NB332Z	NB333Z	NB334Z	NB335Z	NB336Z	NB337Z	NB338Z
8 x 12 mm							
12 x 4 mm							
12 x 8 mm							
12 x 12 mm							



Tibia FP Modular cemented



Types:	T1	T2	T3	T4	T5	T6	T7	T8
Left	NB521Z	NB522Z	NB523Z	NB524Z	NB525Z	NB526Z	NB527Z	NB528Z
Right	NB621Z	NB622Z	NB623Z	NB624Z	NB625Z	NB626Z	NB627Z	NB628Z

Tibia UC/PS Pro Modular cemented



Types:	T1	T2	T3	T4	T5	T6	T7	T8
Left	NX731Z	NX732Z	NX733Z	NX734Z	NX735Z	NX736Z	NX737Z	NX738Z
Right	NX781Z	NX782Z	NX783Z	NX784Z	NX785Z	NX786Z	NX787Z	NX788Z

Tibia-Obturator



Types:	Ø 12	Ø 14	Ø 16
T1/T2/T3	NB105Z	--	--
T4/T5/T6	--	NB106Z	--
T7/T8	--	--	NB107Z

Tibia-Obturator for UC Pro



Types:	AS	Ø 14
		NN264Z

Tibia UC/PS Modular cemented



Types:	T1	T2	T3	T4	T5	T6	T7	T8
Left	NB731Z	NB732Z	NB733Z	NB734Z	NB735Z	NB736Z	NB737Z	NB738Z
Right	NB781Z	NB782Z	NB783Z	NB784Z	NB785Z	NB786Z	NB787Z	NB788Z

Rotation Axis for Meniscal Component SW3.5



Types:	10 mm	12 mm	14 mm	16 mm	18 mm	20 mm	22 mm	24 mm
UC	NR900Z	NR910Z	NR920Z	NR930Z	NR940Z	NR950Z	--	--
PS	NB900Z	NB910Z	NB920Z	NB930Z	NB940Z	NB950Z	NB960Z	NB980Z

Rotation Axis for Meniscal Component SW4.5



Types:	Height mm	10	12	14	16	18	20	22	24
UC	NR801Z	NR811Z	NR821Z	NR831Z	NR841Z	NR851Z	--	--	--
PS	NB800Z	NB810Z	NB820Z	NB830Z	NB840Z	NB850Z	NB860Z	NB870Z	

PEEK Plug



Types:	Ø 14
	NN260P

Tibial Wedges Medial



Types:	T1	T2	T3	T4	T5	T6	T7	T8
Left + Right	NB401Z	NB402Z	NB403Z	NB404Z	NB405Z	NB406Z	NB407Z	NB408Z

4 mm

Types:	T1	T2	T3	T4	T5	T6	T7	T8
Left	NB421Z	NB422Z	NB423Z	NB424Z	NB425Z	NB426Z	NB427Z	NB428Z
Right	NB431Z	NB432Z	NB433Z	NB434Z	NB435Z	NB436Z	NB437Z	NB438Z

8 mm

Types:	T1	T2	T3	T4	T5	T6	T7	T8
Left	NB461Z	NB462Z	NB463Z	NB464Z	NB465Z	NB466Z	NB467Z	NB468Z
Right	NB471Z	NB472Z	NB473Z	NB474Z	NB475Z	NB476Z	NB477Z	NB478Z

12 mm

Tibia UC/PS Modular cemented



Types:	T1	T2	T3	T4	T5	T6	T7	T8
Left	NB441Z	NB442Z	NB443Z	NB444Z	NB445Z	NB446Z	NB447Z	NB448Z
Right	NB451Z	NB452Z	NB453Z	NB454Z	NB455Z	NB456Z	NB457Z	NB458Z

Rotation Axis for Meniscal Component SW3.5



Types:	10 mm	12 mm	14 mm	16 mm	18 mm	20 mm	22 mm	24 mm
UC	NR900Z	NR910Z	NR920Z	NR930Z	NR940Z	NR950Z	--	--
PS	NB900Z	NB910Z	NB920Z	NB930Z	NB940Z	NB950Z	NB960Z	NB980Z

Rotation Axis for Meniscal Component SW4.5



Types:	Height mm	10	12	14	16	18	20	22	24
UC	NR801Z	NR811Z	NR821Z	NR831Z	NR841Z	NR851Z	--	--	--
PS	NB800Z	NB810Z	NB820Z	NB830Z	NB840Z	NB850Z	NB860Z	NB870Z	

PEEK Plug



Types:	Ø 14
	NN260P

Tibial Wedges Lateral



Types:	T1	T2	T3	T4	T5	T6	T7	T8
Left + Right	NB411Z	NB412Z	NB413Z	NB414Z	NB415Z	NB416Z	NB417Z	NB418Z

4 mm

Types:	T1	T2	T3	T4	T5	T6	T7	T8
Left	NB441Z	NB442Z	NB443Z	NB444Z	NB445Z	NB446Z	NB447Z	NB448Z
Right	NB451Z	NB452Z	NB453Z	NB454Z	NB455Z	NB456Z	NB457Z	NB458Z

8 mm

Types:	T1	T2	T3	T4	T5	T6	T7	T8
Left	NB481Z	NB482Z	NB483Z	NB484Z	NB485Z	NB486Z	NB487Z	NB488Z
Right	NB491Z	NB492Z	NB493Z	NB494Z	NB495Z	NB496Z	NB497Z	NB498Z

12 mm

Meniscal Component FP, UC, PS

Types:	FP – left								UC – left								PS – left							
	F2	F3	F4	F5	F6	F7	F8	F8	F2	F3	F4	F5	F6	F7	F8	F8	F2	F3	F4	F5	F6	F7	F8	
10	N0542	N0543	N0544	N0545	N0546	N0547	N0548	N0548	NR802	NR803	NR804	NR805	NR806	NR807	NR808	NR808	NB802	NB803	NB804	NB805	NB806	NB807	NB808	
12	N0552	N0553	N0554	N0555	N0556	N0557	N0558	N0558	NR812	NR813	NR814	NR815	NR816	NR817	NR818	NR818	NB812	NB813	NB814	NB815	NB816	NB817	NB818	
14	N0562	N0563	N0564	N0565	N0566	N0567	N0568	N0568	NR822	NR823	NR824	NR825	NR826	NR827	NR828	NR828	NB822	NB823	NB824	NB825	NB826	NB827	NB828	
16	N0572	N0573	N0574	N0575	N0576	N0577	N0578	N0578	NR832	NR833	NR834	NR835	NR836	NR837	NR838	NR838	NB832	NB833	NB834	NB835	NB836	NB837	NB838	
18									NR842	NR843	NR844	NR845	NR846	NR847	NR848	NR848	NB842	NB843	NB844	NB845	NB846	NB847	NB848	
20									NR852	NR853	NR854	NR855	NR856	NR857	NR858	NR858	NB852	NB853	NB854	NB855	NB856	NB857	NB858	
22																	NB864	NB865	NB866	NB867	NB868	NB869	NB870	
24																	NB874	NB875	NB876	NB877	NB878	NB879	NB880	

Meniscal Component UC Pro, PS Pro

Types:	FP – right								UC – right								PS – right							
	F2	F3	F4	F5	F6	F7	F8	F8	F2	F3	F4	F5	F6	F7	F8	F8	F2	F3	F4	F5	F6	F7	F8	
10	N0642	N0643	N0644	N0645	N0646	N0647	N0648	N0648	NR902	NR903	NR904	NR905	NR906	NR907	NR908	NR908	NB902	NB903	NB904	NB905	NB906	NB907	NB908	
12	N0652	N0653	N0654	N0655	N0656	N0657	N0658	N0658	NR912	NR913	NR914	NR915	NR916	NR917	NR918	NR918	NB912	NB913	NB914	NB915	NB916	NB917	NB918	
14	N0662	N0663	N0664	N0665	N0666	N0667	N0668	N0668	NR922	NR923	NR924	NR925	NR926	NR927	NR928	NR928	NB922	NB923	NB924	NB925	NB926	NB927	NB928	
16	N0672	N0673	N0674	N0675	N0676	N0677	N0678	N0678	NR932	NR933	NR934	NR935	NR936	NR937	NR938	NR938	NB932	NB933	NB934	NB935	NB936	NB937	NB938	
18									NR942	NR943	NR944	NR945	NR946	NR947	NR948	NR948	NB942	NB943	NB944	NB945	NB946	NB947	NB948	
20									NR952	NR953	NR954	NR955	NR956	NR957	NR958	NR958	NB952	NB953	NB954	NB955	NB956	NB957	NB958	
22																	NB964	NB965	NB966	NB967	NB968	NB969	NB970	
24																	NB974	NB975	NB976	NB977	NB978	NB979	NB980	

Meniscal Component UC Pro, PS Pro

Types:	UC Pro – left								PS Pro – left							
	F2	F3	F4	F5	F6	F7	F8	F8	F2	F3	F4	F5	F6	F7	F8	
10	NX402	NX403	NX404	NX405	NX406	NX407	NX408	NX408	NX802	NX803	NX804	NX805	NX806	NX807	NX808	
12	NX412	NX413	NX414	NX415	NX416	NX417	NX418	NX418	NX812	NX813	NX814	NX815	NX816	NX817	NX818	
14	NX422	NX423	NX424	NX425	NX426	NX427	NX428	NX428	NX822	NX823	NX824	NX825	NX826	NX827	NX828	
16	NX432	NX433	NX434	NX435	NX436	NX437	NX438	NX438	NX832	NX833	NX834	NX835	NX836	NX837	NX838	
18	NX442	NX443	NX444	NX445	NX446	NX447	NX448	NX448	NX842	NX843	NX844	NX845	NX846	NX847	NX848	
20	NX452	NX453	NX454	NX455	NX456	NX457	NX458	NX458	NX852	NX853	NX854	NX855	NX856	NX857	NX858	

Meniscal Component UC Pro, PS Pro

Types:	UC Pro – right								PS Pro – right							
	F2	F3	F4	F5	F6	F7	F8	F8	F2	F3	F4	F5	F6	F7	F8	
10	NX502	NX503	NX504	NX505	NX506	NX507	NX508	NX508	NX902	NX903	NX904	NX905	NX906	NX907	NX908	
12	NX512	NX513	NX514	NX515	NX516	NX517	NX518	NX518	NX912	NX913	NX914	NX915	NX916	NX917	NX918	
14	NX522	NX523	NX524	NX525	NX526	NX527	NX528	NX528	NX922	NX923	NX924	NX925	NX926	NX927	NX928	
16	NX532	NX533	NX534	NX535	NX536	NX537	NX538	NX538	NX932	NX933	NX934	NX935	NX936	NX937	NX938	
18	NX542	NX543	NX544	NX545	NX546	NX547	NX548	NX548	NX942	NX943	NX944	NX945	NX946	NX947	NX948	
20	NX552	NX553	NX554	NX555	NX556	NX557	NX558	NX558	NX952	NX953	NX954	NX955	NX956	NX957	NX958	

e.motion® specific stems for PS/UC/FP Tibia

Femur Extension Stems cementless



Types:	5°				7°			
	Ø 14	Ø 16	Ø 18	Ø 20	Ø 14	Ø 16	Ø 18	Ø 20
Short	NB236K	NB237K	NB238K	NB239K	NB256K	NB257K	NB258K	NB259K
Middle	NB241K	NB242K	NB243K	NB244K	NB261K	NB262K	NB263K	NB264K
Long	NB246K	NB247K	NB248K	NB249K	NB266K	NB267K	NB268K	NB269K

Femur Ext. Stems cemented



Types:	5°		7°	
	Ø 14	Ø 16	Ø 14	Ø 16
Short	NB145K	NB144K	NB135K	NB134K
Middle	NB150K	NB149K	NB137K	NB136K
Long	NB155K	NB154K	NB139K	NB138K

Nut for Femur Ext. Stem



NB140K

AS e.motion® specific stems for PS/UC/FP Tibia

Femur Extension Stems cementless



Types:	5°				7°			
	Ø 14	Ø 16	Ø 18	Ø 20	Ø 14	Ø 16	Ø 18	Ø 20
Short	NB236Z	NB237Z	NB238Z	NB239Z	NB256Z	NB257Z	NB258Z	NB259Z
Middle	NB241Z	NB242Z	NB243Z	NB244Z	NB261Z	NB262Z	NB263Z	NB264Z
Long	NB246Z	NB247Z	NB248Z	NB249Z	NB266Z	NB267Z	NB268Z	NB269Z

Femur Ext. Stems cemented



Types:	5°		7°	
	Ø 14	Ø 16	Ø 14	Ø 16
Short	NB145Z	NB144Z	NB135Z	NB134Z
Middle	NB150Z	NB149Z	NB137Z	NB136Z
Long	NB155Z	NB154Z	NB139Z	NB138Z

Nut for Femur Ext. Stem



NB140Z

Tibia Ext. Stems cemented



Types:	Ø 12			Ø 14			Ø 16		
	Short	Middle	Long	Short	Middle	Long	Short	Middle	Long
Short	NB213K	NB214K	NB215K	NB213K	NB214K	NB215K	NB213K	NB214K	NB215K
Middle	NB218K	NB219K	NB220K	NB218K	NB219K	NB220K	NB218K	NB219K	NB220K
Long	NB223K	NB224K	NB225K	NB223K	NB224K	NB225K	NB223K	NB224K	NB225K

Tibia Ext. Stems cementless



Types:	Ø 10			Ø 12			Ø 14			Ø 16		
	Short	Middle	Long	Short	Middle	Long	Short	Middle	Long	Short	Middle	Long
Short	NB114K	NB115K	NB116K	NB114K	NB115K	NB116K	NB114K	NB115K	NB116K	NB114K	NB115K	NB116K
Middle	NB094K	NB095K	NB096K	NB094K	NB095K	NB096K	NB094K	NB095K	NB096K	NB094K	NB095K	NB096K
Long	NB124K	NB125K	NB126K	NB124K	NB125K	NB126K	NB124K	NB125K	NB126K	NB124K	NB125K	NB126K

Tibia Ext. Stems cemented



Types:	Ø 12			Ø 14			Ø 16		
	Short	Middle	Long	Short	Middle	Long	Short	Middle	Long
Short	NB213Z	NB214Z	NB215Z	NB213Z	NB214Z	NB215Z	NB213Z	NB214Z	NB215Z
Middle	NB218Z	NB219Z	NB220Z	NB218Z	NB219Z	NB220Z	NB218Z	NB219Z	NB220Z
Long	NB223Z	NB224Z	NB225Z	NB223Z	NB224Z	NB225Z	NB223Z	NB224Z	NB225Z

Tibia Ext. Stems cementless



Types:	Ø 10			Ø 12			Ø 14			Ø 16		
	Short	Middle	Long	Short	Middle	Long	Short	Middle	Long	Short	Middle	Long
Short	NB114Z	NB115Z	NB116Z	NB114Z	NB115Z	NB116Z	NB114Z	NB115Z	NB116Z	NB114Z	NB115Z	NB116Z
Middle	NB094Z	NB095Z	NB096Z	NB094Z	NB095Z	NB096Z	NB094Z	NB095Z	NB096Z	NB094Z	NB095Z	NB096Z
Long	NB124Z	NB125Z	NB126Z	NB124Z	NB125Z	NB126Z	NB124Z	NB125Z	NB126Z	NB124Z	NB125Z	NB126Z

Aesculap stems for PS/UC Pro Tibia



Types:	Ø 10		Ø 12		Ø 14							
	Length mm	52	92	52	92	52	92					
Standard	NX060K	NX061K	NX062K	NX064K	NX063K	NX065K	NX060Z	NX061Z	NX062Z	NX064Z	NX063Z	NX065Z

Tibia Stems cementless



Types:	Ø 10		Ø 12		Ø 14		Ø 14					
	Length mm	92	132	92	132	92	132	132				
Standard	NX082K	NX083K	NX084K	NX086K	NX085K	NX087K	NX082Z	NX083Z	NX084Z	NX086Z	NX085Z	NX087Z

Tibia Stems Short cementless



Types:	Ø 14	
	Length mm	12
Standard	NB100K	NB100Z

